

MD-11 SERIES

HOT BRAKES

Normal cooling: Move aircraft to a suitable location and allow brakes to cool on their own.
 Water mist: Can be deployed from turret or handline.
 Fans: Placing fans may place firefighters very close to the hazard zone.

WHEEL FIRE

Apply large amounts of water initially with turrets. Transition to handline application to continue and maintain a cooling effect.
Wheels are equipped with fusible plugs designed to melt and deflate the tire when the temperature is excessive.

WARNING: Approach landing gear trucks from forward or aft at a 45 degree angle when approaching hot brakes or fighting a wheel fire, as rims and tires may pose a fragmentation hazard.

FLAMMABLE MATERIAL LOCATIONS

CAUTION: Rescue crews wearing full PPE to include SCBA's must use caution when moving across sections of aircraft that have been exposed to fatigue or fire as the result of an accident. Crews need to verify the integrity of the surface area before moving their weight and equipment across it. Signs could include but are not limited to deformity of structure, visual signs of flame impingement or uneven surfaces. Surface integrity can be checked with a pike pole, axe or any instrument used to sound surfaces for integrity.

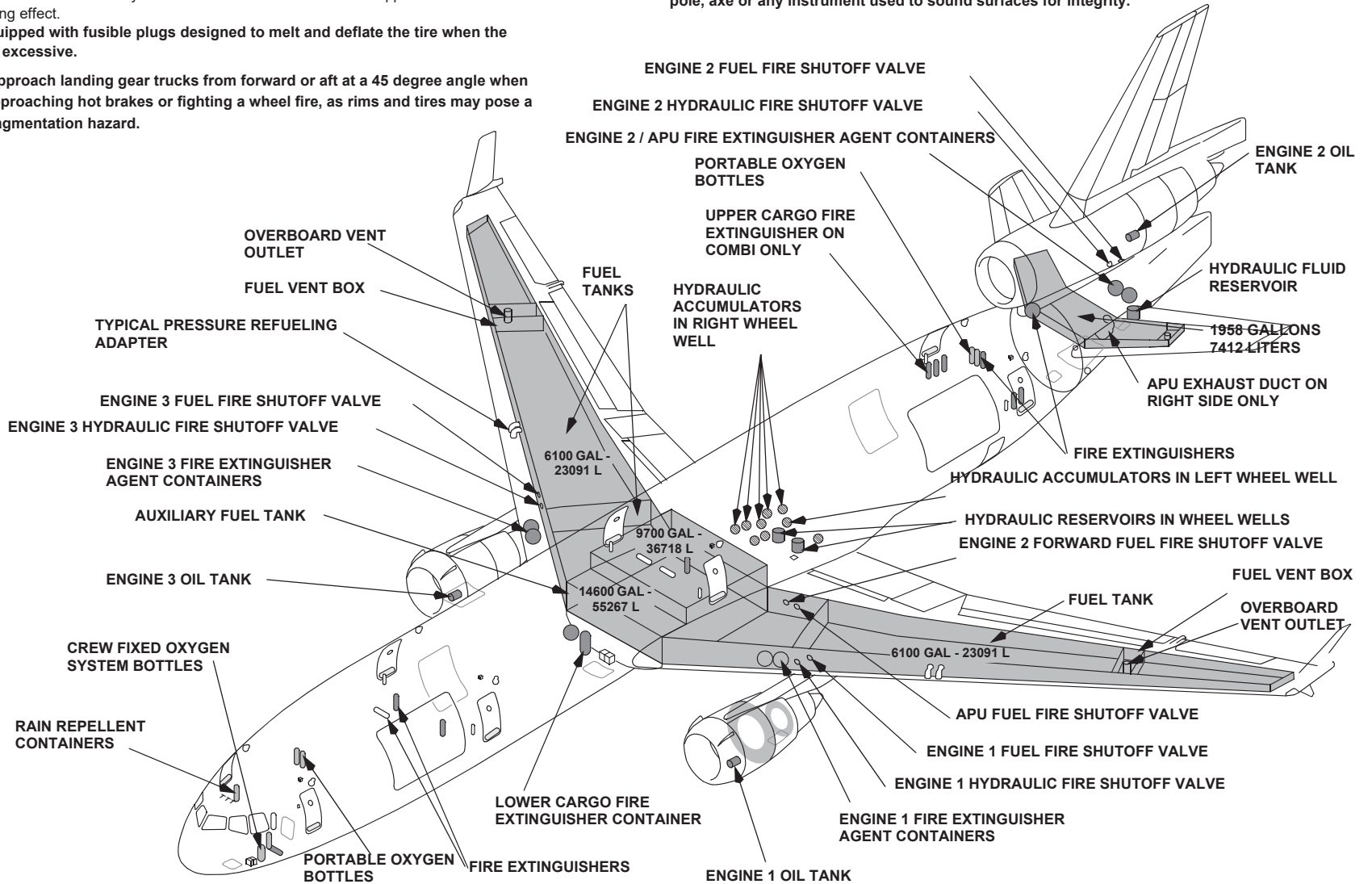

Copyright © Boeing. See title page for details.

MD-11 SERIES

1 PASSENGER AND SERVICE DOORS

EMERGENCY RESCUE ACCESS-1

PUSH BUTTON TYPE

NOTE: WHEN MOVED TO "EMERGENCY" POSITION AND HELD, ALLOWS DOOR CONTROL HANDLE TO BE MOVED TO "EMERGENCY" POSITION FOR EMERGENCY OPENING OF THE DOOR IF ELECTRICAL POWER IS NOT AVAILABLE.

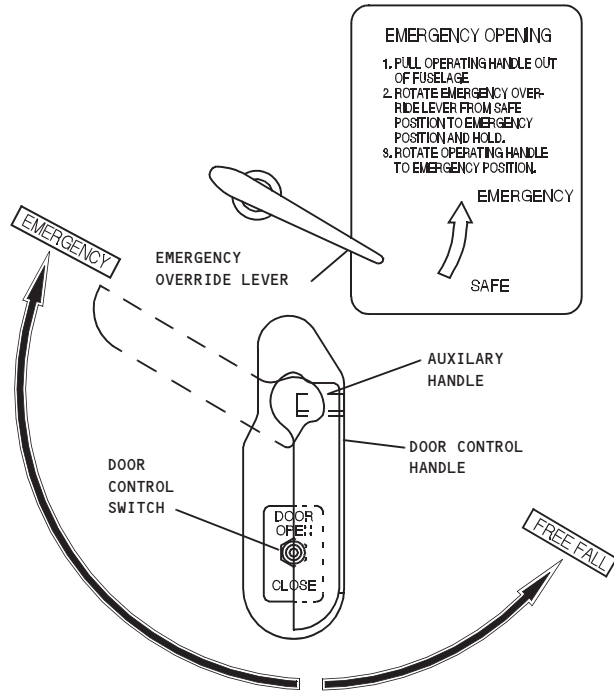

NON PUSH BUTTON TYPE

NOTE: WHEN PLACED IN "EMERGENCY" POSITION, DOOR CONTROL HANDLE WILL REMAIN IN THAT POSITION.

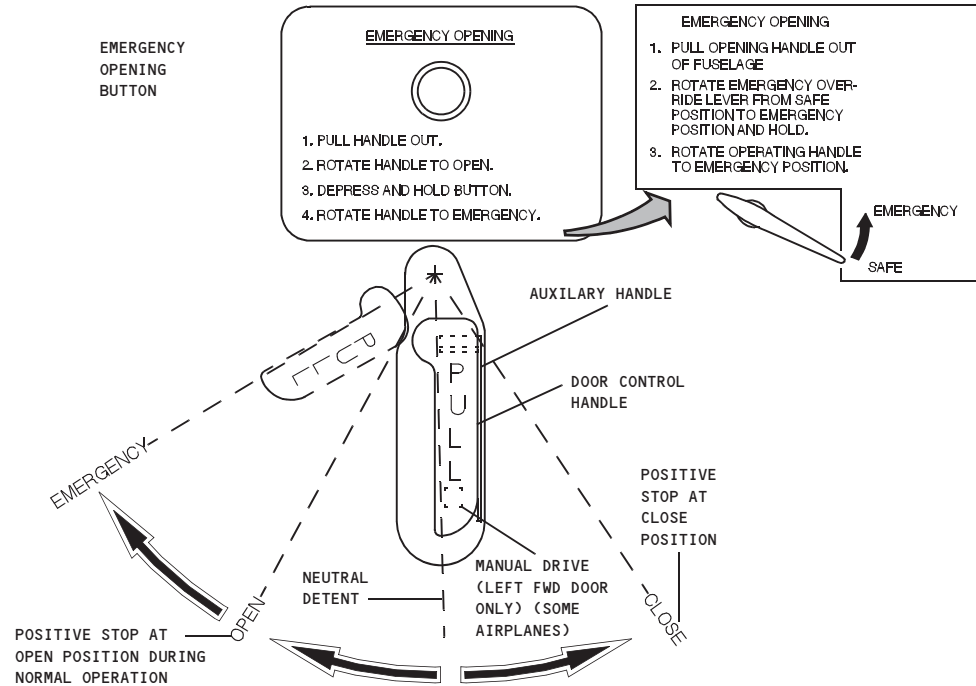

MD-11 SERIES

2 CARGO ACCESS DOORS

EMERGENCY RESCUE ACCESS-2

MANUAL OPERATION
WARNING:
 DOOR MAY SPRING OPEN
 PRIOR TO MANUALLY UNLATCHING.
 MANUALLY CRANK DOOR ACTUATOR
 TO THE FULLY CLOSED POSITION.
 DO NOT ATTEMPT TO PRY DOOR
 OPEN, OR OPEN DOOR ELECTRICALLY
 IF DOOR IS COVERED WITH ICE.
DO NOT USE POWER TOOLS
TO UNLOCK AND UNLATCH DOOR:
 1. PLACE VENT DOOR HANDLE IN
 OPEN POSITION.
 2. TURN ACTUATOR DRIVE UNTIL
 LATCHES ARE OPEN.
TO LATCH AND LOCK DOOR:
 1. TURN ACTUATOR DRIVE UNTIL
 VENT DOOR HANDLE CAN BE
 CLOSED.

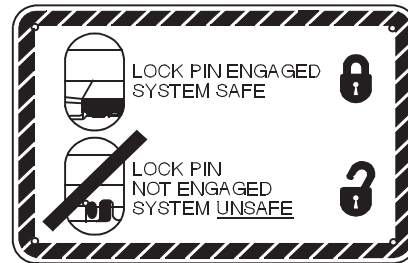
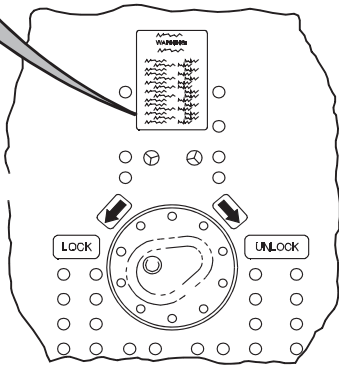
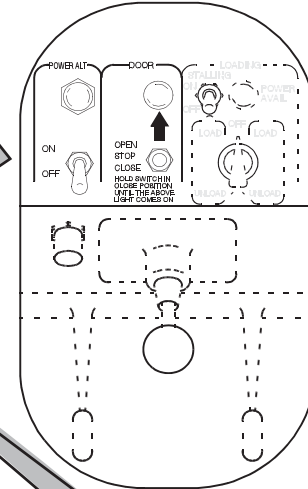
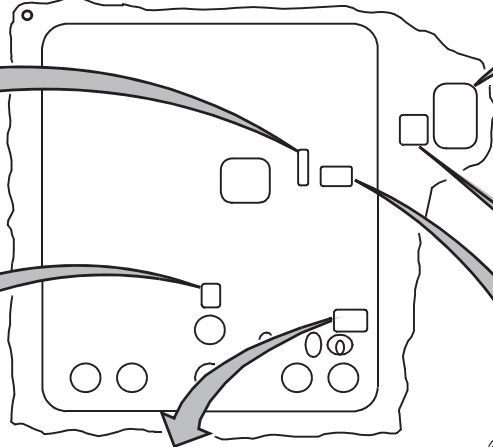
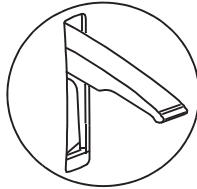

CAUTION
 DO NOT FORCE HANDLE
 IF HANDLE WILL NOT OPERATE
 RESTORE POWER TO DOOR AND
 HOLD DOOR CONTROL SWITCH
 TO DOOR CLOSE POSITION FOR
 ADDITIONAL THREE SECONDS
 MOVE HANDLE TO CLOSE POSITION



4 CUT-IN AREAS

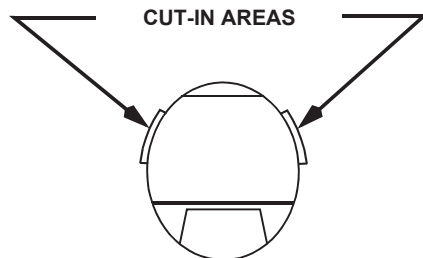

NOTE: CUT-IN AREAS REQUIRE METAL CUTTING PORTABLE POWER EQUIPMENT. BECAUSE OF TYPE OF STRUCTURE AND POSSIBLE INJURY TO PERSONNEL WITHIN, IT IS RECOMMENDED THAT MAJOR EFFORT TO GAIN ACCESS BE DIRECTED TO HATCHES AND DOORS. URGENCY OF SITUATION WILL DICTATE THE NECESSITY FOR A CUT-IN.

MD-11 SERIES

3 UPPER CARGO DOOR

EMERGENCY RESCUE ACCESS-3

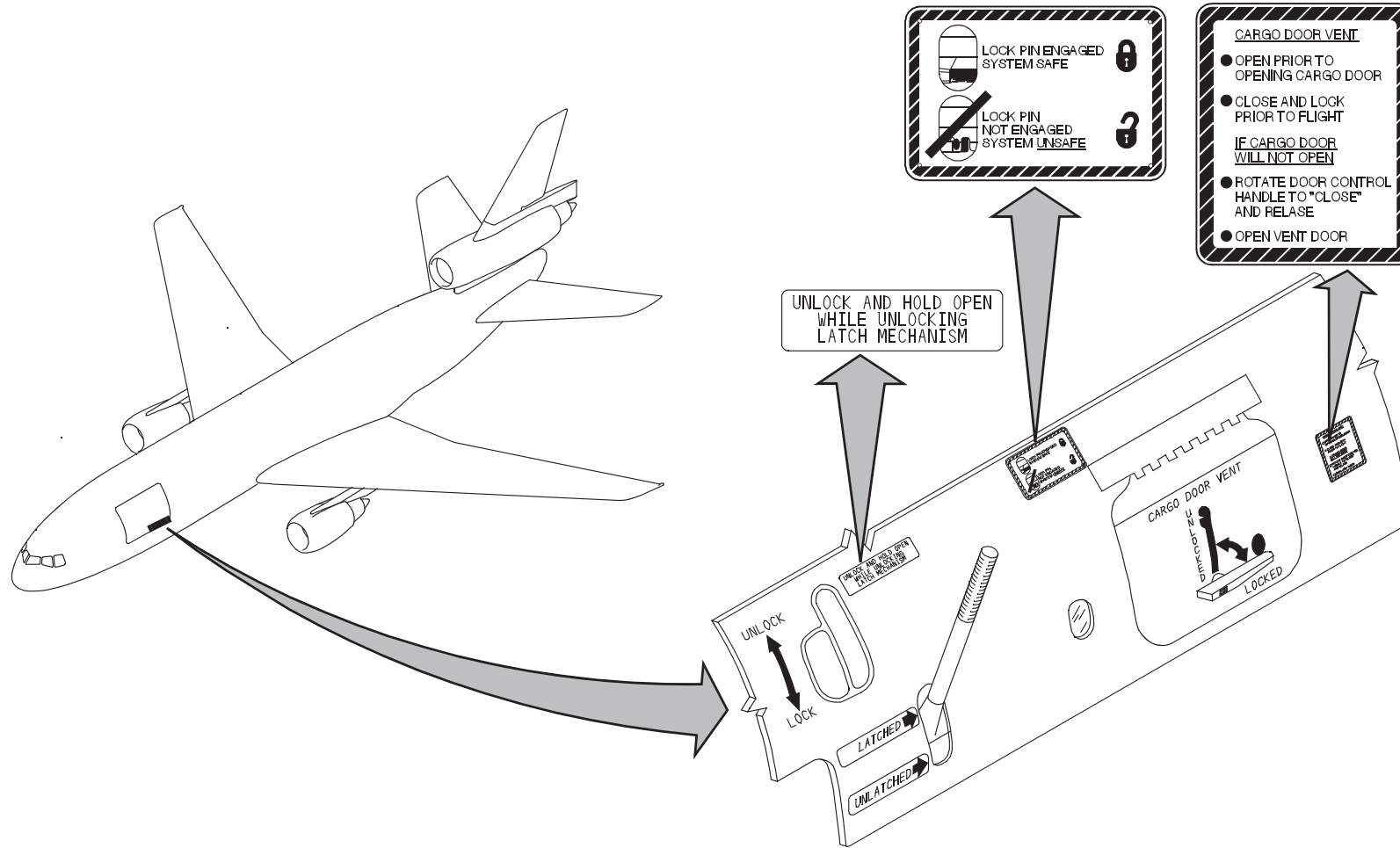

MD-11 SERIES

EMERGENCY RESCUE ACCESS-4

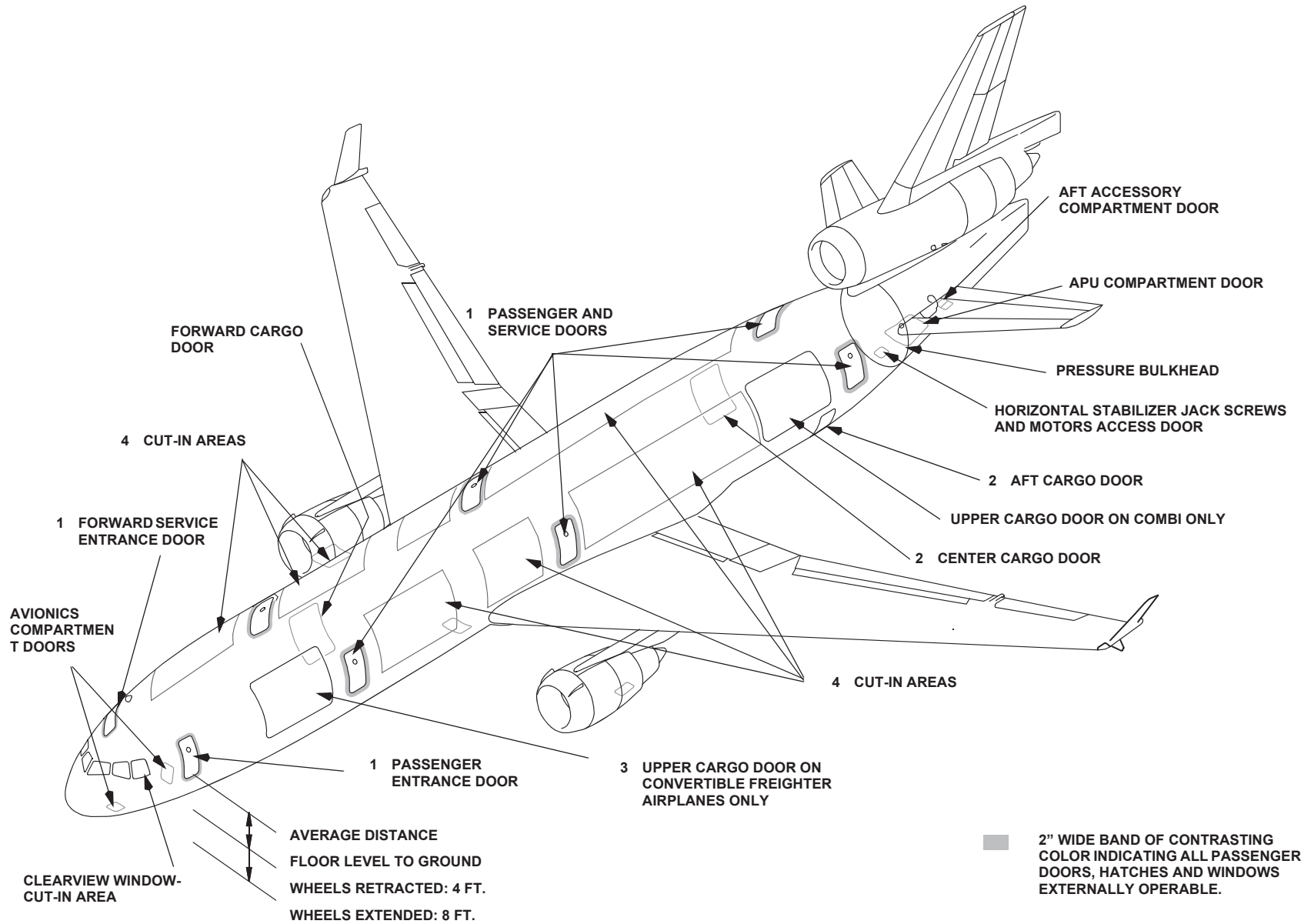

Copyright © Boeing. See title page for details.

MD-11 SERIES

BATTERY LOCATIONS

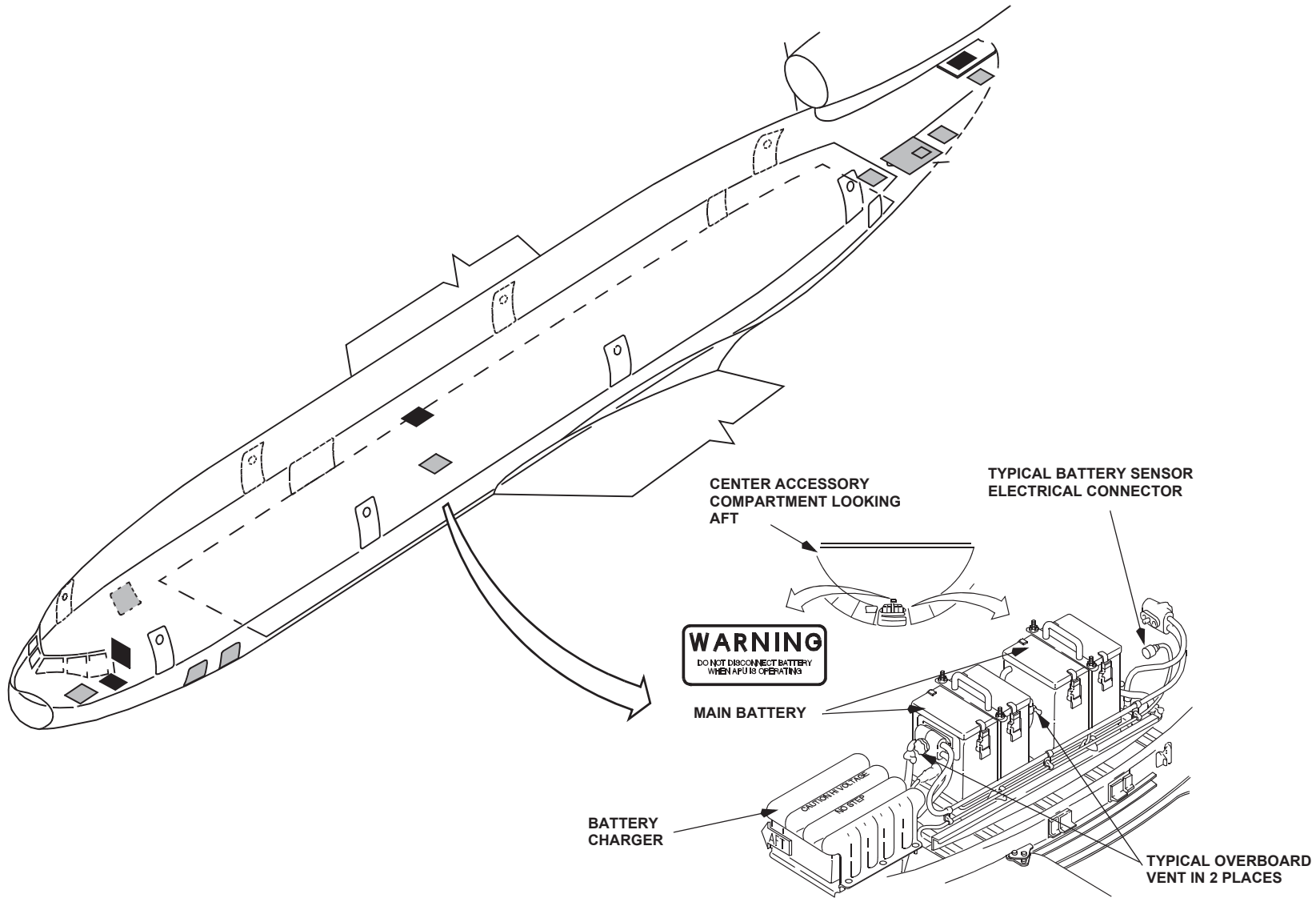

MD-11 SERIES

FLIGHT DECK CONTROL SWITCH LOCATIONS

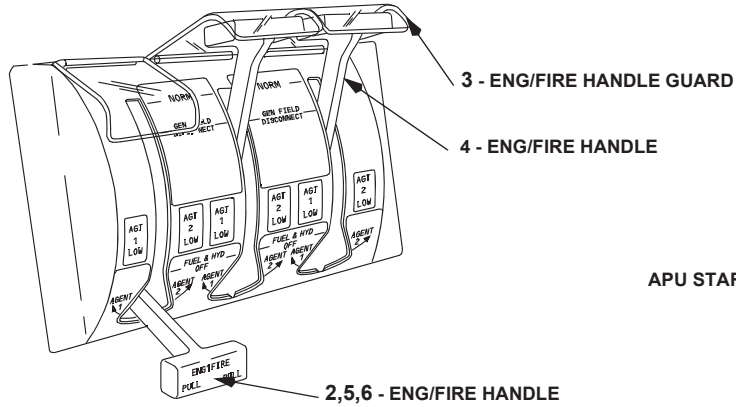

AFT OVERHEAD PANEL

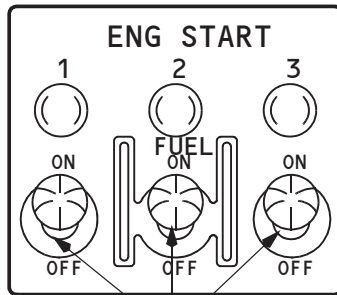

1 - ENGINE FUEL SWITCHES

CONTROL STAND

APU START/STOP SWITCH

2,3 APU FIRE HANDLE

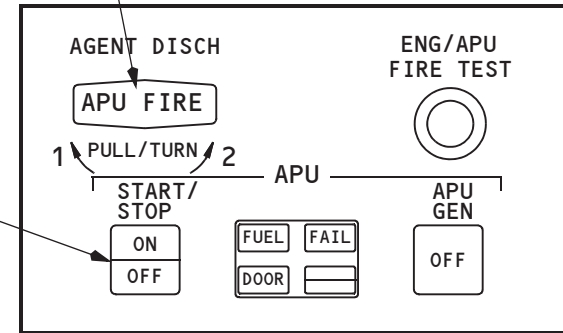

AFT OVERHEAD PANEL

APU SHUTDOWN AND FIRE PROCEDURE

1. PUSH APU START/STOP SWITCH TO OFF.
2. IF "APU FIRE" LIGHT IN HANDLE IS ILLUMINATED:
3. PULL AND ROTATE APU FIRE HANDLE IN EITHER DIRECTION
4. AFTER 30 SECONDS , PULL AND ROTATE APU FIRE HANDLE IN THE OPPOSITE DIRECTION.

ENGINE SHUTDOWN AND FIRE PROCEDURE:

1. FUEL SWITCH(ES) FROM "ON" TO "OFF" (DOWN.)
2. IF LIGHT(S) IN FUEL SWITCH(ES) OR "ENG FIRE" HANDLE(S) ARE ILLUMINATED:
3. LIFT "ENG/FIRE" HANDLE GUARD(S)
4. PULL HANDLE(S) DOWN AND FORWARD
5. WHILE HOLDING FORWARD PRESSURE ON HANDLE, TWIST HANDLE CLOCKWISE AND HOLD
6. AFTER 30 SECONDS, TWIST HANDLE COUNTERCLOCKWISE.

CRITICAL SWITCH LOCATIONS AND THEIR OPERATION ARE SHOWN WITH THE EXPANDED VIEWS OF THE CONTROL MODULES.

MD-11 SERIES

EXTERNAL APU FIRE CONTROLS

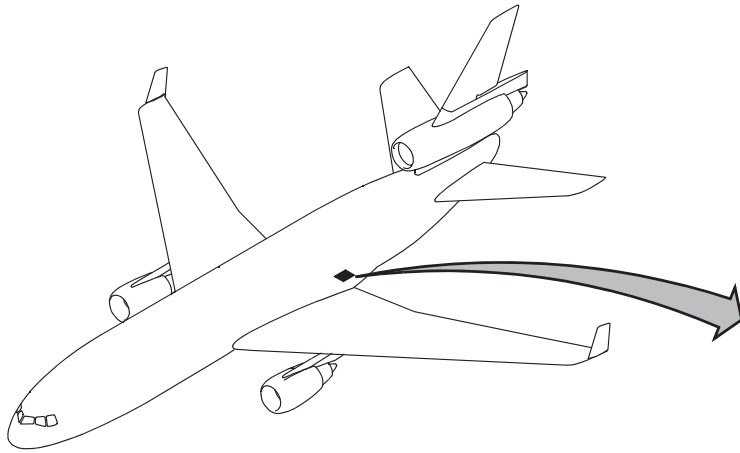

APU SHUTDOWN AND FIRE PROCEDURE:

1. TURN APU SWITCH TO "OFF" (UP).
2. IF APU FIRE LIGHT IS ON...
3. FIRE AGENT 1 SWITCH TO "DISCHARGE" (UP).
4. AFTER 30 SECONDS, FIRE AGENT 2 SWITCH TO "DISCHARGE" (UP).

