

DC-8 SERIES

FLAMMABLE MATERIAL LOCATIONS

CAUTION: Rescue crews wearing full PPE to include SCBA's must use caution when moving across sections of aircraft that have been exposed to fatigue or fire as the result of an accident. Crews need to verify the integrity of the surface area before moving their weight and equipment across it. Signs could include but are not limited to deformity of structure, visual signs of flame impingement or uneven surfaces. Surface integrity can be checked with a pike pole, axe or any instrument used to sound surfaces for integrity.

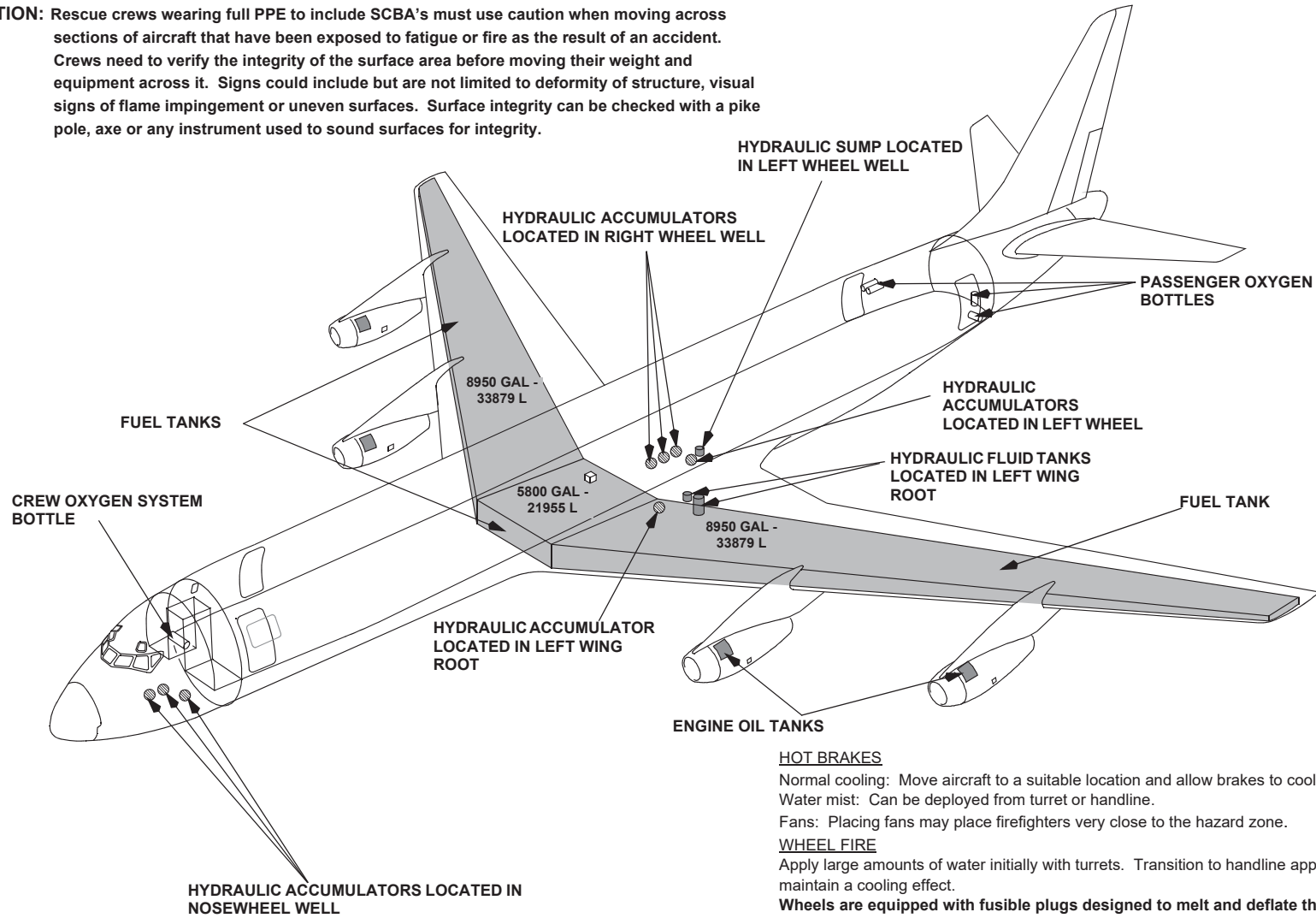

HOT BRAKES

Normal cooling: Move aircraft to a suitable location and allow brakes to cool on their own.
 Water mist: Can be deployed from turret or handline.

Fans: Placing fans may place firefighters very close to the hazard zone.

WHEEL FIRE

Apply large amounts of water initially with turrets. Transition to handline application to continue and maintain a cooling effect.

Wheels are equipped with fusible plugs designed to melt and deflate the tire when the temperature is excessive.

WARNING: Approach landing gear trucks from forward or aft at a 45 degree angle when approaching hot brakes or fighting a wheel fire, as rims and tires may pose a fragmentation hazard.

DC-8 SERIES

EMERGENCY RESCUE ACCESS-1

1 PASSENGER AND SERVICE DOORS

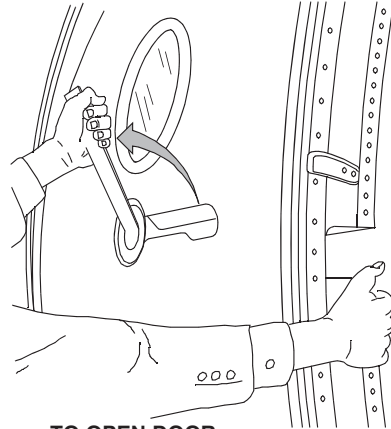

- TO OPEN DOOR:**
1. PULL HANDLE FROM RECESS.
 2. ROTATE HANDLE FORWARD.
 3. PULL DOOR OPEN.

2 EMERGENCY EXIT

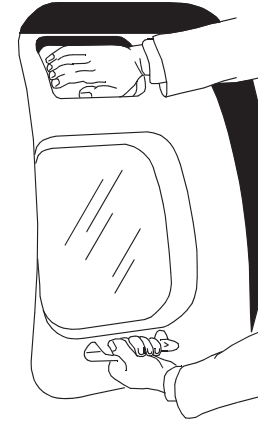

- TO OPEN DOOR:**
1. HOLD HANDLE.
 2. PUSH RELEASE PLATE (HANDLE ON SOME AIRPLANES ONLY).

3 CUT-IN AREAS

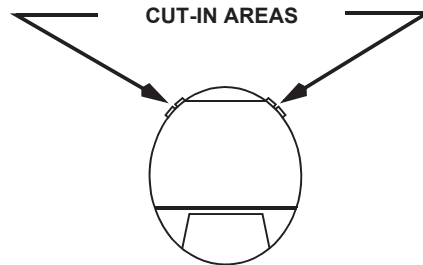

NOTE: CUT-IN AREAS REQUIRE METAL CUTTING PORTABLE POWER EQUIPMENT. BECAUSE OF TYPE OF STRUCTURE AND POSSIBLE INJURY TO PERSONNEL WITHIN, IT IS RECOMMENDED THAT MAJOR EFFORT TO GAIN ACCESS BE DIRECTED TO HATCHES AND DOORS. URGENCY OF SITUATION WILL DICTATE THE NECESSITY FOR A CUT-IN.

DC-8 SERIES

EMERGENCY RESCUE ACCESS-2

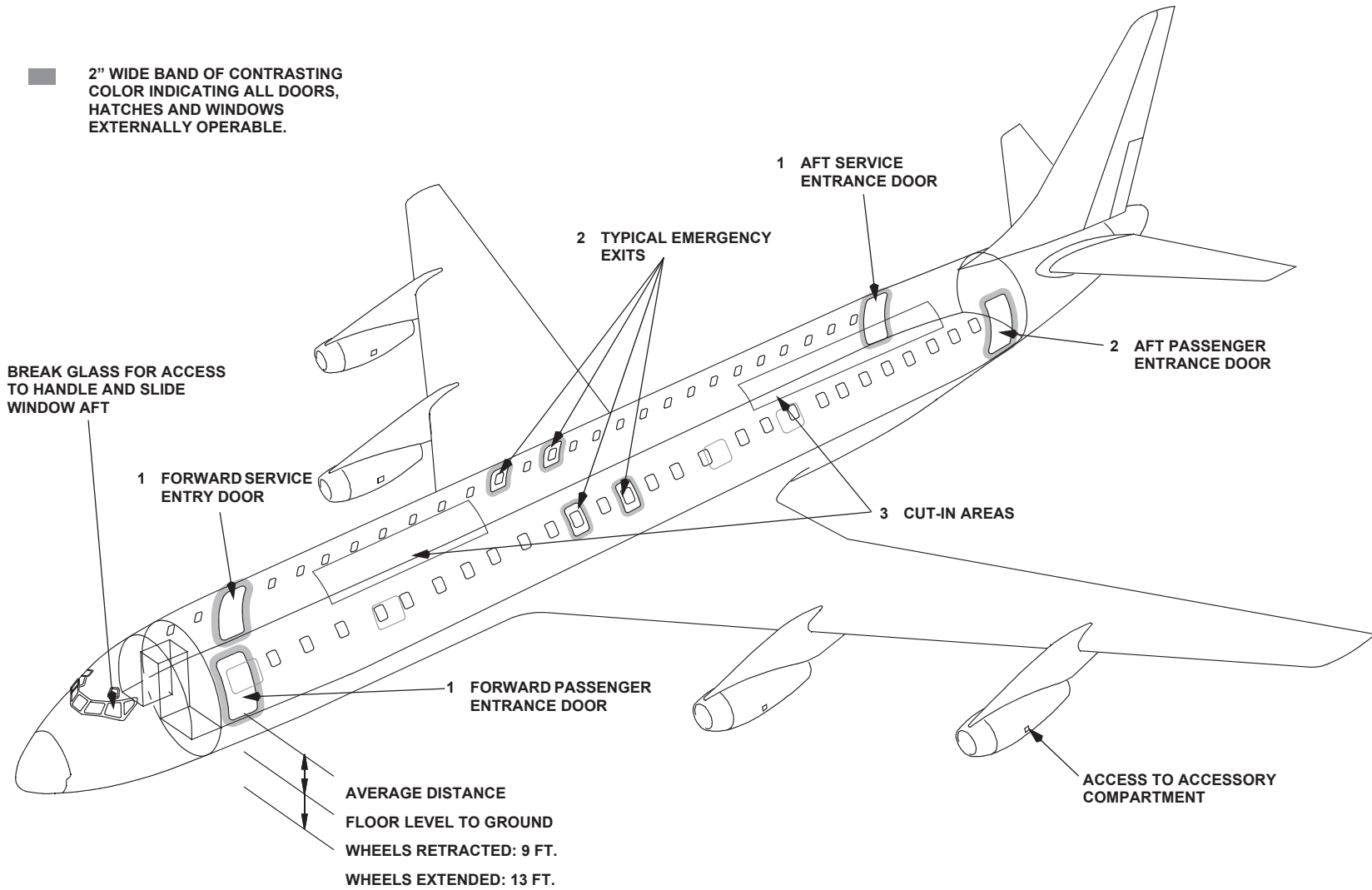

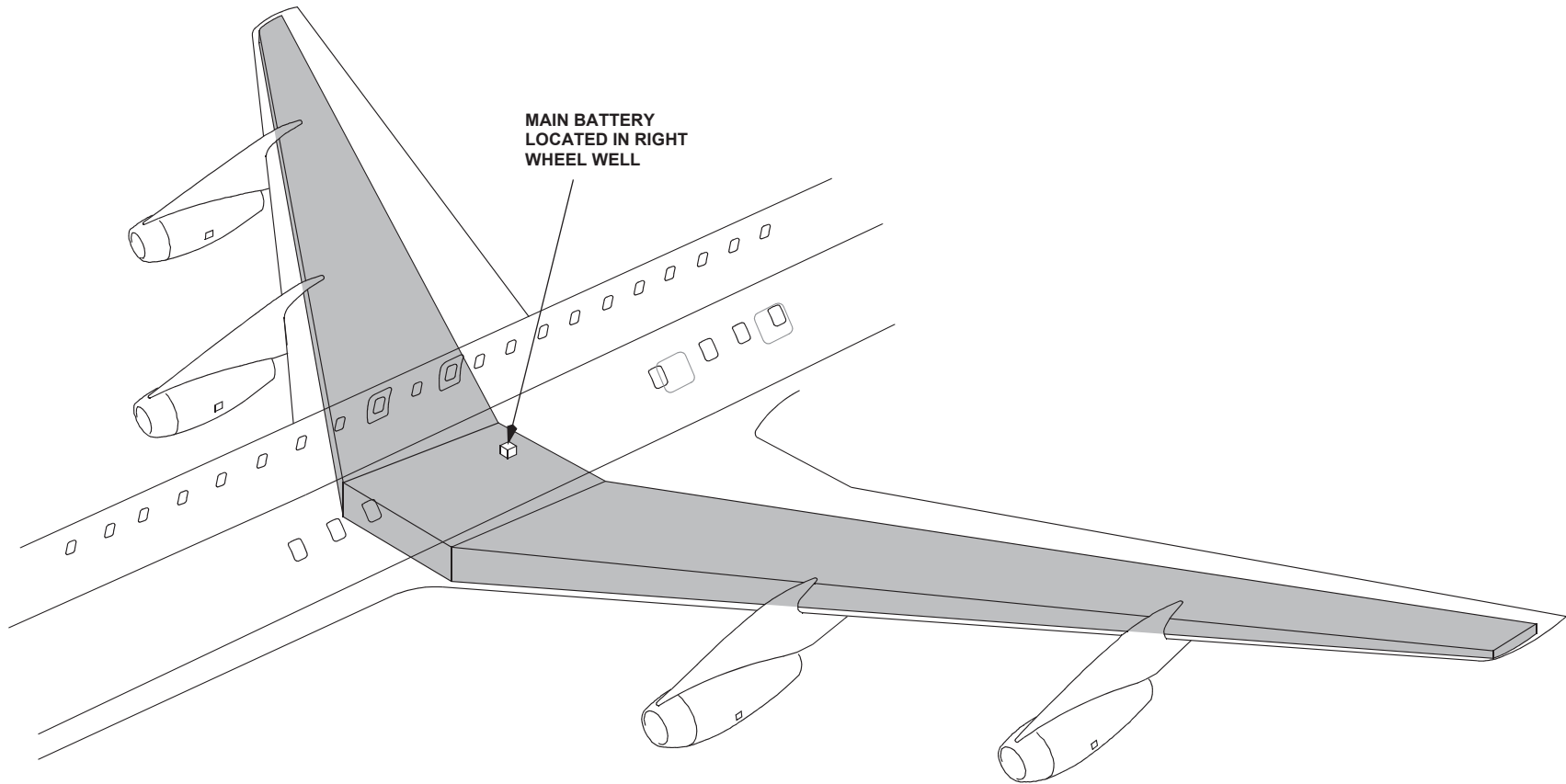

DC-8 FREIGHTER SERIES

FLAMMABLE MATERIAL LOCATIONS

CAUTION: Rescue crews wearing full PPE to include SCBA's must use caution when moving across sections of aircraft that have been exposed to fatigue or fire as the result of an accident. Crews need to verify the integrity of the surface area before moving their weight and equipment across it. Signs could include but are not limited to deformity of structure, visual signs of flame impingement or uneven surfaces. Surface integrity can be checked with a pike pole, axe or any instrument used to sound surfaces for integrity.

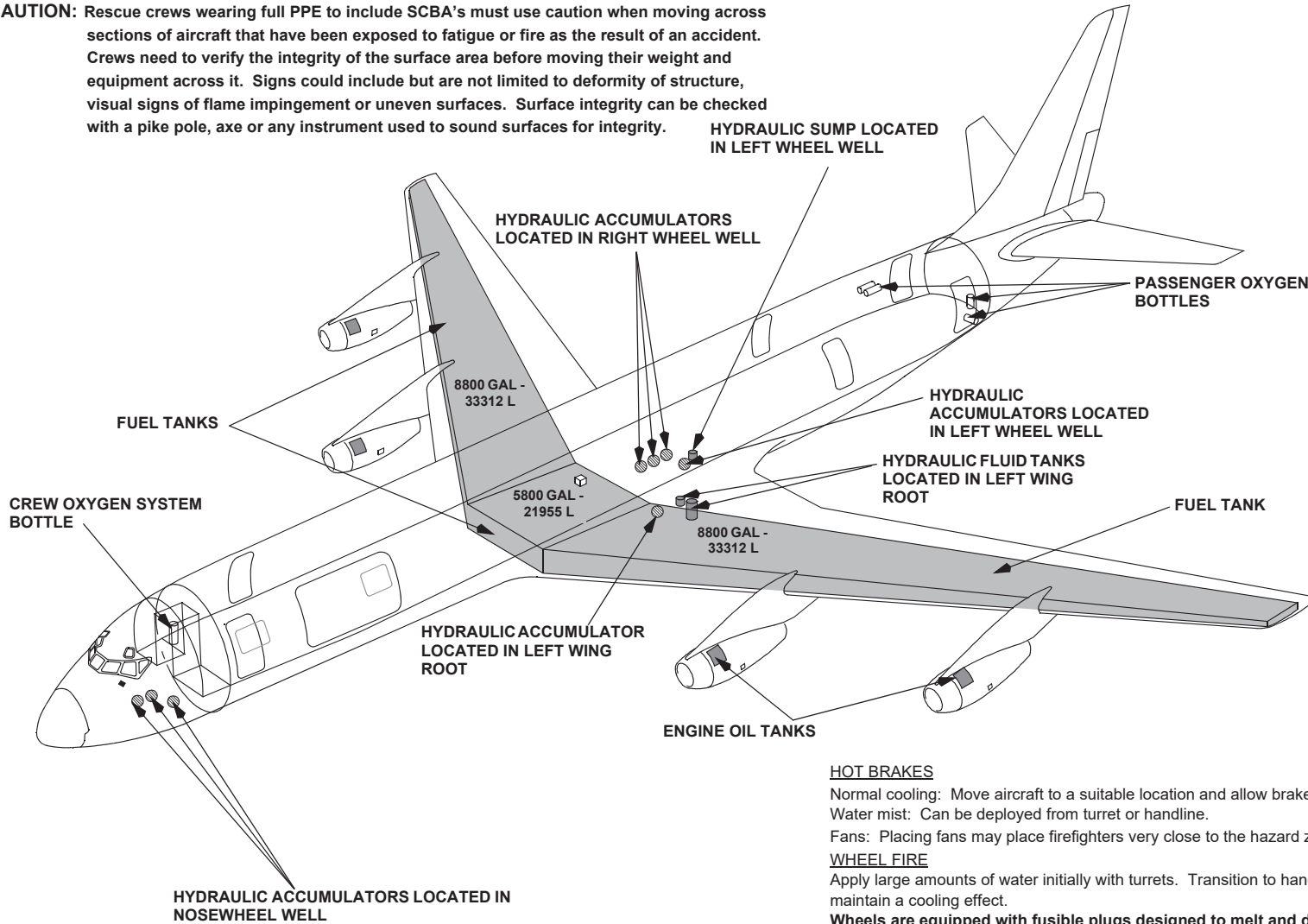

HOT BRAKES

Normal cooling: Move aircraft to a suitable location and allow brakes to cool on their own.
 Water mist: Can be deployed from turret or handline.
 Fans: Placing fans may place firefighters very close to the hazard zone.

WHEEL FIRE

Apply large amounts of water initially with turrets. Transition to handline application to continue and maintain a cooling effect.
 Wheels are equipped with fusible plugs designed to melt and deflate the tire when the temperature is excessive.

WARNING: Approach landing gear trucks from forward or aft at a 45 degree angle when approaching hot brakes or fighting a wheel fire, as rims and tires may pose a fragmentation hazard.

DC-8 FREIGHTER SERIES

EMERGENCY RESCUE ACCESS-1

1 PASSENGER AND SERVICE DOORS

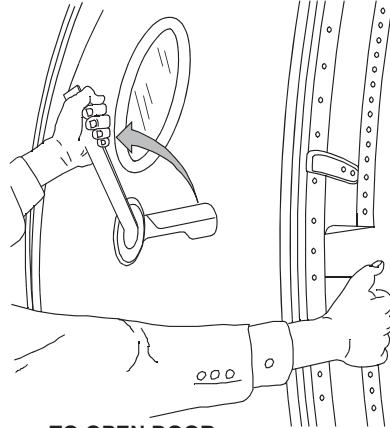

- TO OPEN DOOR:**
1. PULL HANDLE FROM RECESS.
 2. ROTATE HANDLE FORWARD.
 3. PULL DOOR OPEN.

2 EMERGENCY EXIT

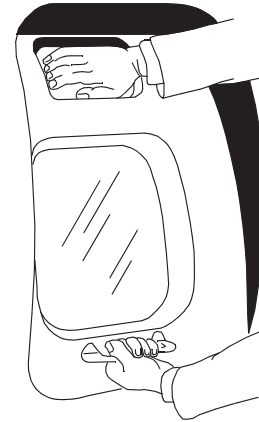

- TO OPEN DOOR:**
1. HOLD HANDLE.
 2. PUSH RELEASE PLATE (HANDLE ON SOME AIRPLANES ONLY).

3 CUT-IN AREAS

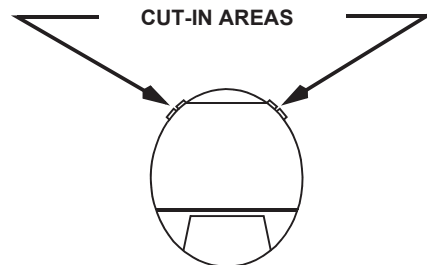

NOTE: CUT-IN AREAS REQUIRE METAL CUTTING PORTABLE POWER EQUIPMENT. BECAUSE OF TYPE OF STRUCTURE AND POSSIBLE INJURY TO PERSONNEL WITHIN, IT IS RECOMMENDED THAT MAJOR EFFORT TO GAIN ACCESS BE DIRECTED TO HATCHES AND DOORS. URGENCY OF SITUATION WILL DICTATE THE NECESSITY FOR CUT-IN.

DC-8 FREIGHTER SERIES

EMERGENCY RESCUE ACCESS-2

■ 2" WIDE BAND OF CONTRASTING COLOR INDICATING ALL PASSENGER DOORS, HATCHES AND WINDOWS EXTERNALLY OPERABLE.

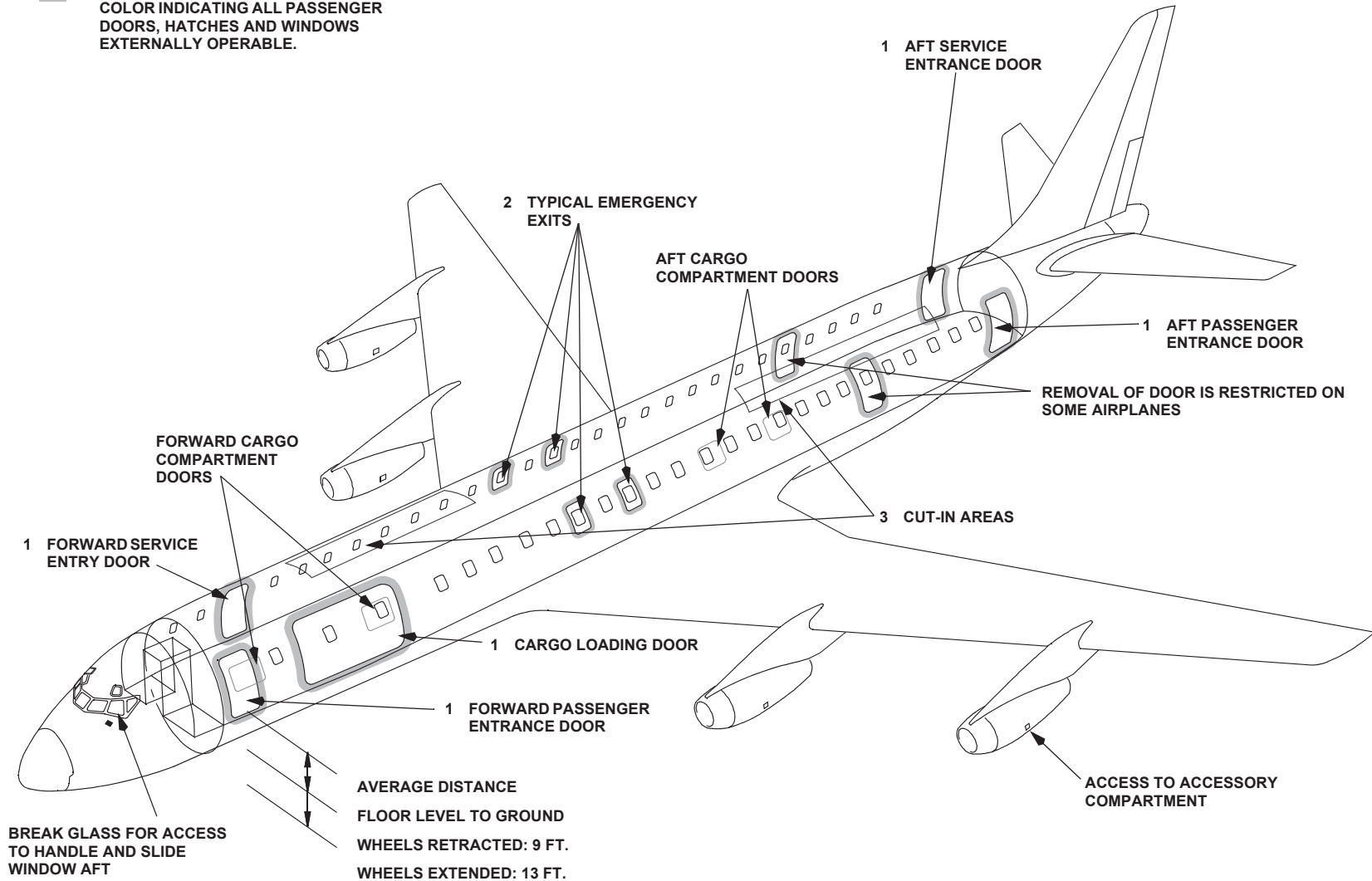

DC-8 FREIGHTER SERIES

BATTERY LOCATIONS

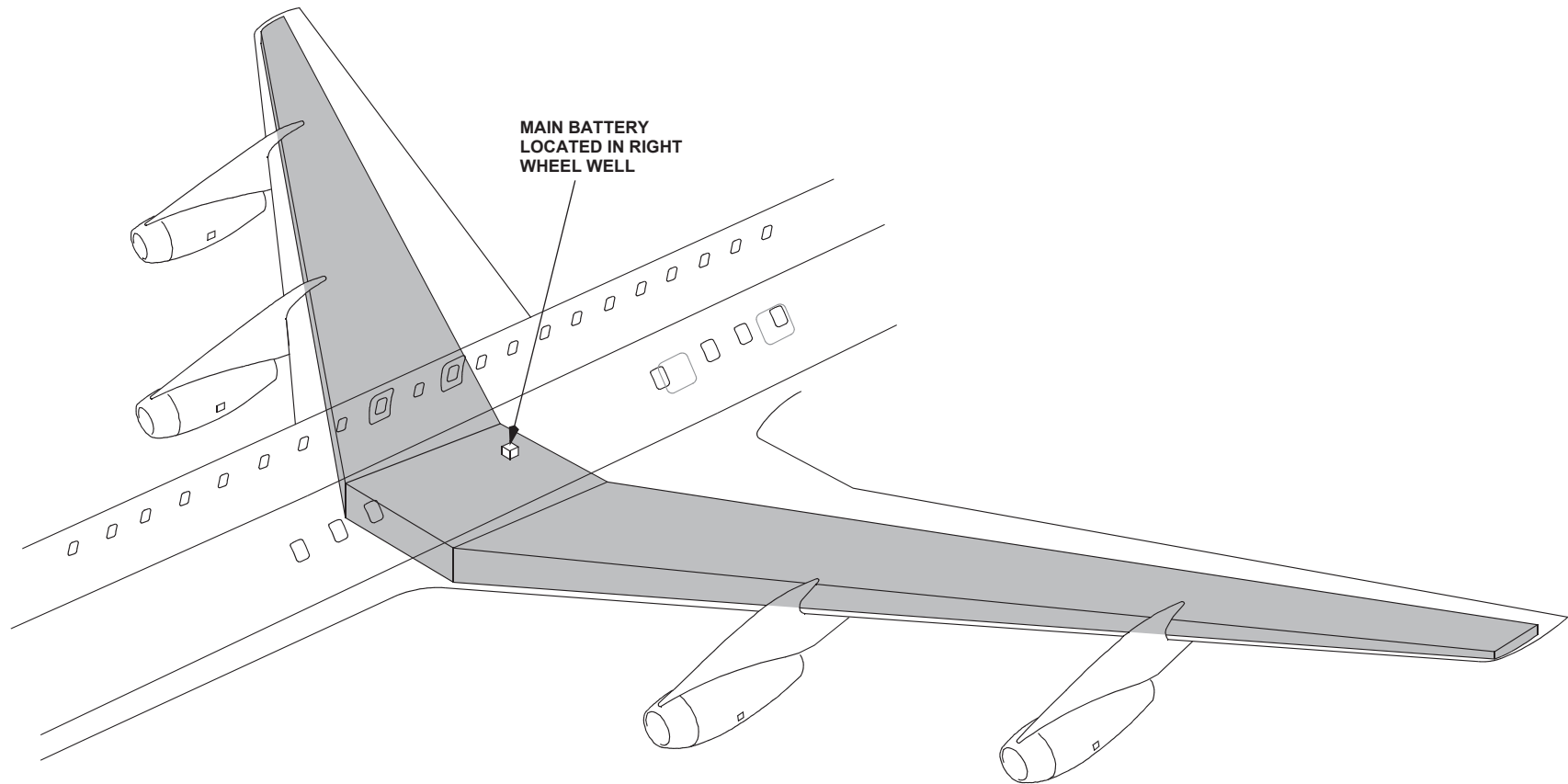

DC-8-61 SERIES

FLAMMABLE MATERIAL LOCATIONS

CAUTION: Rescue crews wearing full PPE to include SCBA's must use caution when moving across sections of aircraft that have been exposed to fatigue or fire as the result of an accident. Crews need to verify the integrity of the surface area before moving their weight and equipment across it. Signs could include but are not limited to deformity of structure, visual signs of flame impingement or uneven surfaces. Surface integrity can be checked with a pike pole, axe or any instrument used to sound surfaces for integrity.

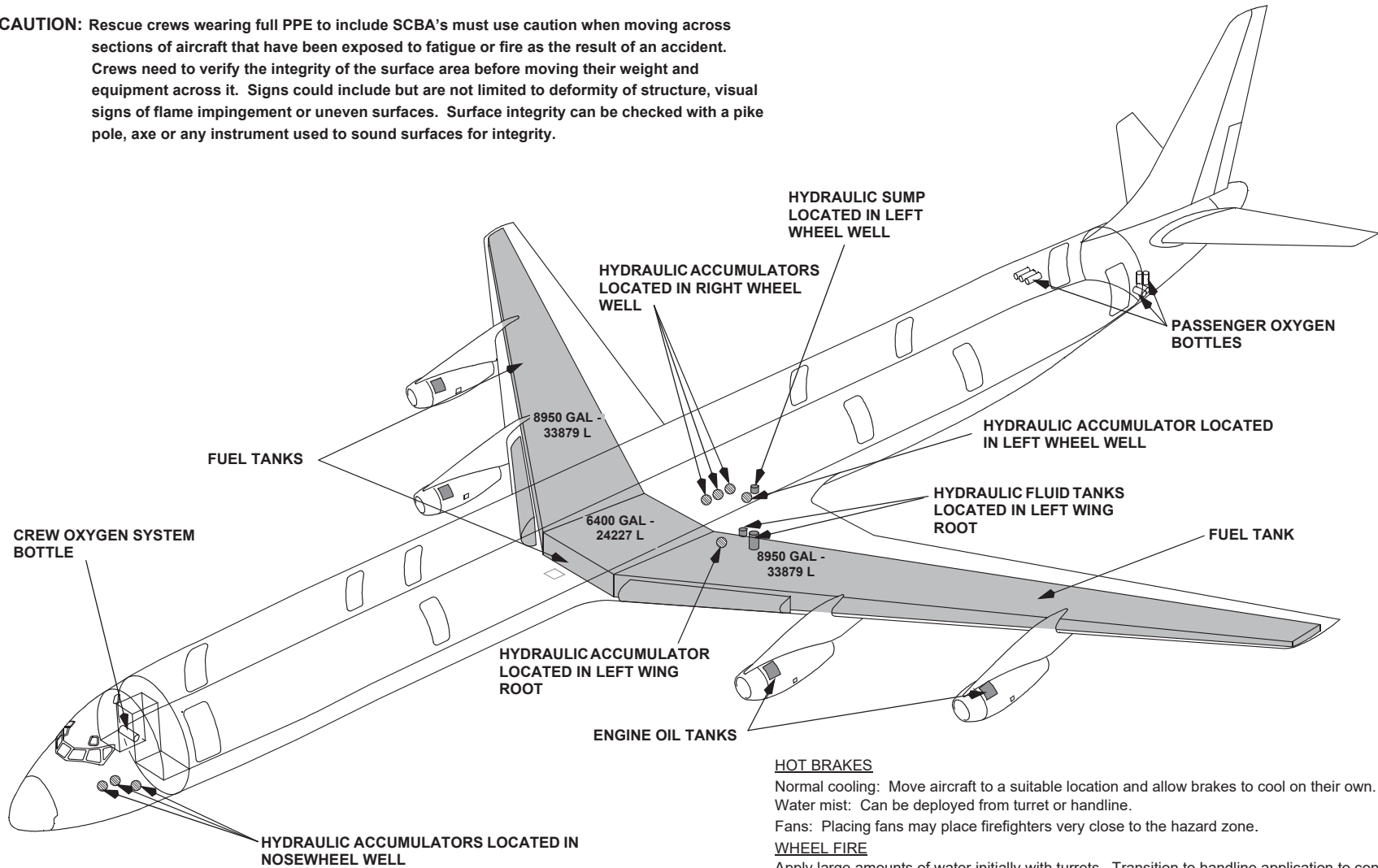

HOT BRAKES

Normal cooling: Move aircraft to a suitable location and allow brakes to cool on their own.
 Water mist: Can be deployed from turret or handline.
 Fans: Placing fans may place firefighters very close to the hazard zone.

WHEEL FIRE

Apply large amounts of water initially with turrets. Transition to handline application to continue and maintain a cooling effect.
Wheels are equipped with fusible plugs designed to melt and deflate the tire when the temperature is excessive.

WARNING: Approach landing gear trucks from forward or aft at a 45 degree angle when approaching hot brakes or fighting a wheel fire, as rims and tires may pose a fragmentation hazard.

DC-8-61 SERIES

EMERGENCY RESCUE ACCESS-1

1 PASSENGER AND SERVICE DOORS

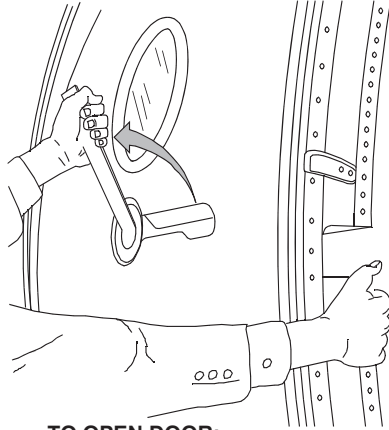

- TO OPEN DOOR:**
1. PULL HANDLE FROM RECESS.
 2. ROTATE HANDLE FORWARD.
 3. PULL DOOR OPEN.

2 EMERGENCY EXIT

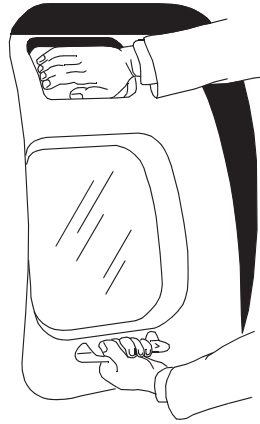

- TO OPEN DOOR:**
1. HOLD HANDLE.
 2. PUSH RELEASE PLATE (HANDLE ON SOME AIRPLANES ONLY).

3 CUT-IN AREAS

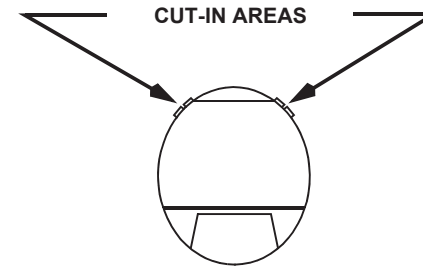

NOTE: CUT-IN AREAS REQUIRE METAL CUTTING PORTABLE POWER EQUIPMENT. BECAUSE OF TYPE OF STRUCTURE AND POSSIBLE INJURY TO PERSONNEL WITHIN, IT IS RECOMMENDED THAT MAJOR EFFORT TO GAIN ACCESS BE DIRECTED TO HATCHES AND DOORS. URGENCY OF SITUATION WILL DICTATE THE NECESSITY FOR A CUT-IN.

4 EMERGENCY EXIT DOORS

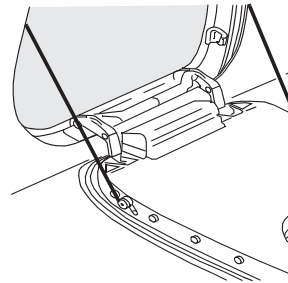
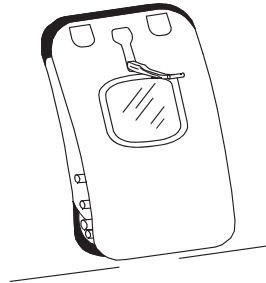

- TO OPEN DOOR:**
1. PULL HANDLE FROM RECESS.
 2. ROTATE HANDLE FORWARD.
 3. PULL DOOR OPEN.

DC-8-61 SERIES

EMERGENCY RESCUE ACCESS-2

■ 2" WIDE BAND OF CONTRASTING COLOR INDICATING ALL PASSENGER DOORS, HATCHES AND WINDOWS EXTERNALLY OPERABLE.

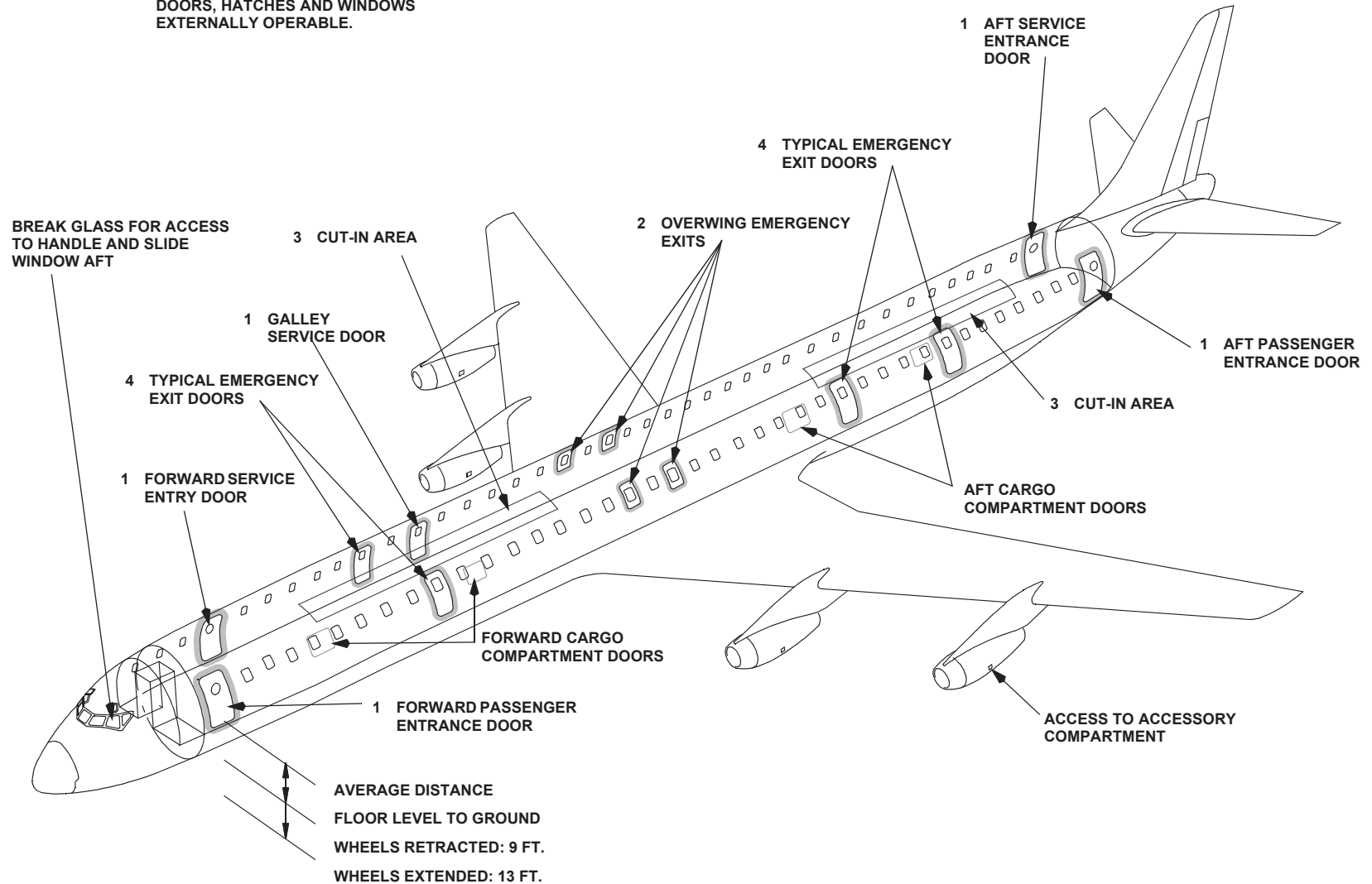

Copyright © Boeing. See title page for details.

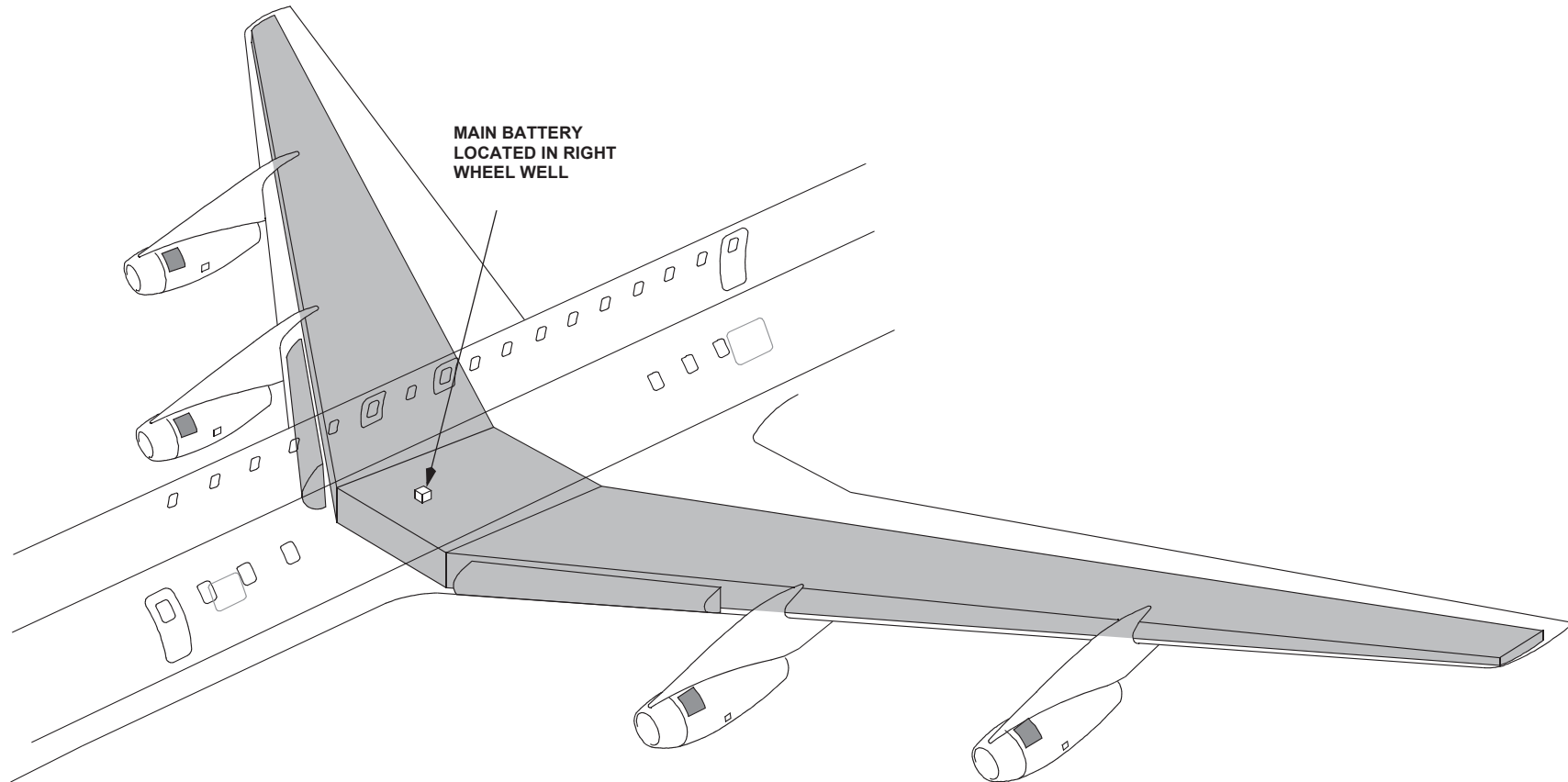

DC-8-62 SERIES

FLAMMABLE MATERIAL LOCATIONS

CAUTION: Rescue crews wearing full PPE to include SCBA's must use caution when moving across sections of aircraft that have been exposed to fatigue or fire as the result of an accident. Crews need to verify the integrity of the surface area before moving their weight and equipment across it. Signs could include but are not limited to deformity of structure, visual signs of flame impingement or uneven surfaces. Surface integrity can be checked with a pike pole, axe or any instrument used to sound surfaces for integrity.

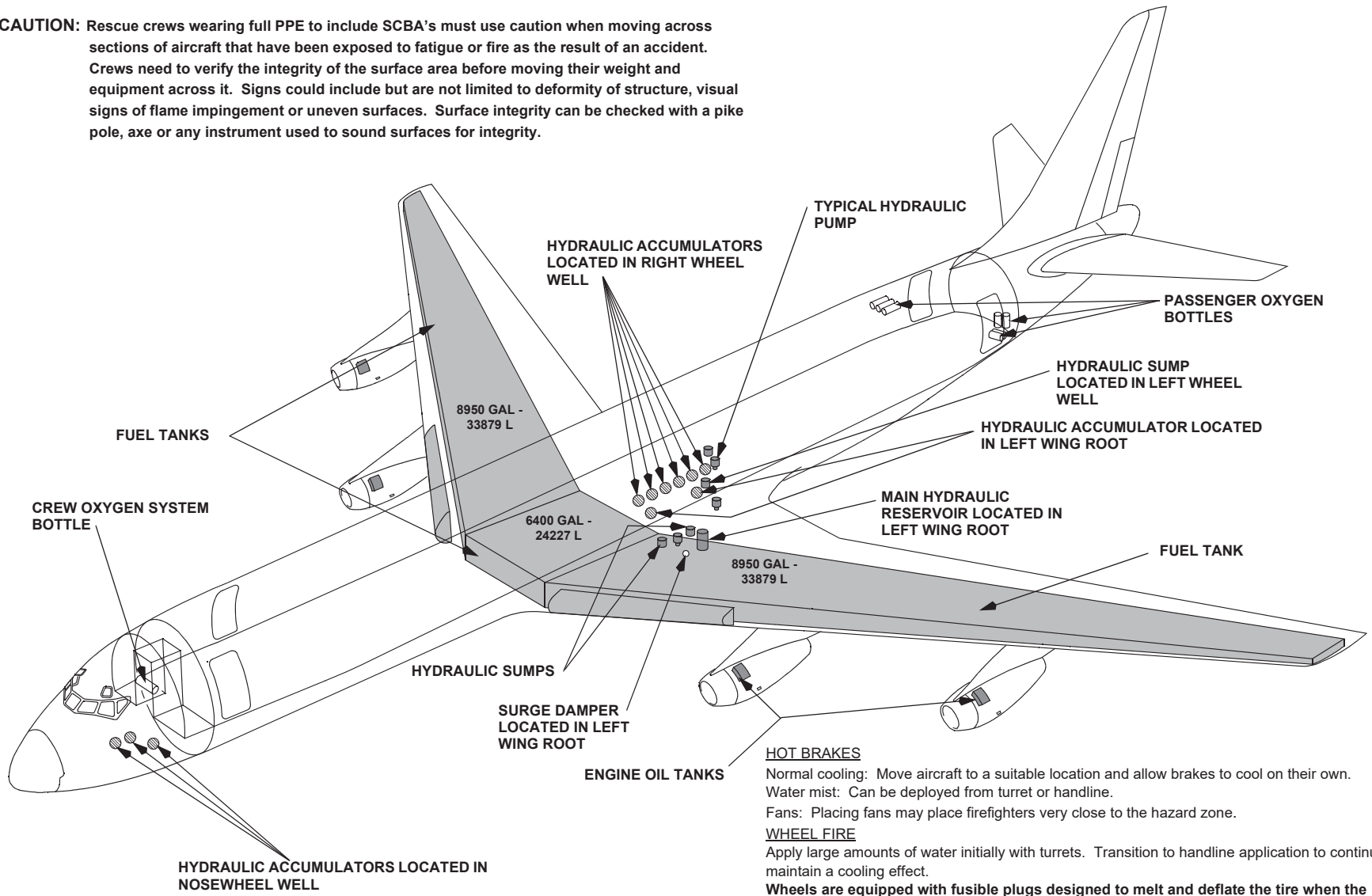

HOT BRAKES
 Normal cooling: Move aircraft to a suitable location and allow brakes to cool on their own.
 Water mist: Can be deployed from turret or handline.
 Fans: Placing fans may place firefighters very close to the hazard zone.

WHEEL FIRE
 Apply large amounts of water initially with turrets. Transition to handline application to continue and maintain a cooling effect.
 Wheels are equipped with fusible plugs designed to melt and deflate the tire when the temperature is excessive.

WARNING: Approach landing gear trucks from forward or aft at a 45 degree angle when approaching hot brakes or fighting a wheel fire, as rims and tires may pose a fragmentation hazard.

Copyright © Boeing. See title page for details.

DC-8-62 SERIES

EMERGENCY RESCUE ACCESS-1

1 PASSENGER AND SERVICE DOORS

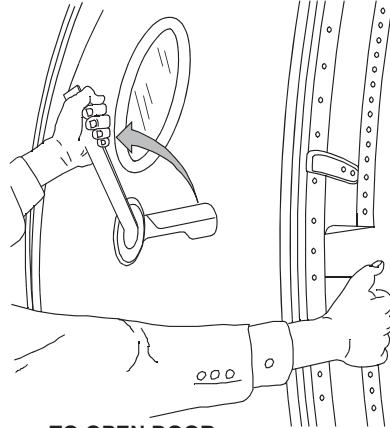

- TO OPEN DOOR:**
1. PULL HANDLE FROM RECESS.
 2. ROTATE HANDLE FORWARD.
 3. PULL DOOR OPEN.

2 EMERGENCY EXIT

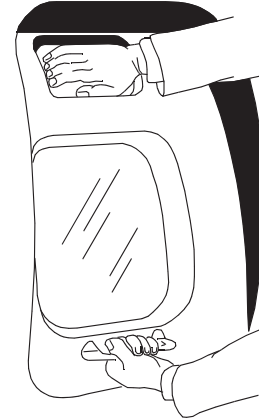

- TO OPEN DOOR:**
1. HOLD HANDLE.
 2. PUSH RELEASE PLATE (HANDLE ON SOME AIRPLANES ONLY).

3 CUT-IN AREAS

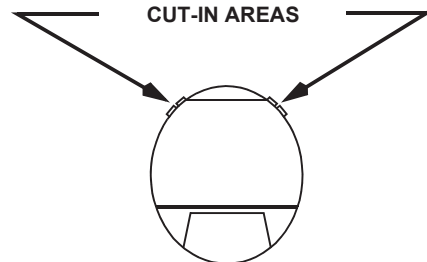

NOTE: CUT-IN AREAS REQUIRE METAL CUTTING PORTABLE POWER EQUIPMENT. BECAUSE OF TYPE OF STRUCTURE AND POSSIBLE INJURY TO PERSONNEL WITHIN, IT IS RECOMMENDED THAT MAJOR EFFORT TO GAIN ACCESS BE DIRECTED TO HATCHES AND DOORS. URGENCY OF SITUATION WILL DICTATE THE NECESSITY FOR A CUT-IN.

DC-8-62 SERIES

EMERGENCY RESCUE ACCESS-2

■ 2" WIDE BAND OF CONTRASTING COLOR INDICATING ALL PASSENGER DOORS, HATCHES AND WINDOWS EXTERNALLY OPERABLE.

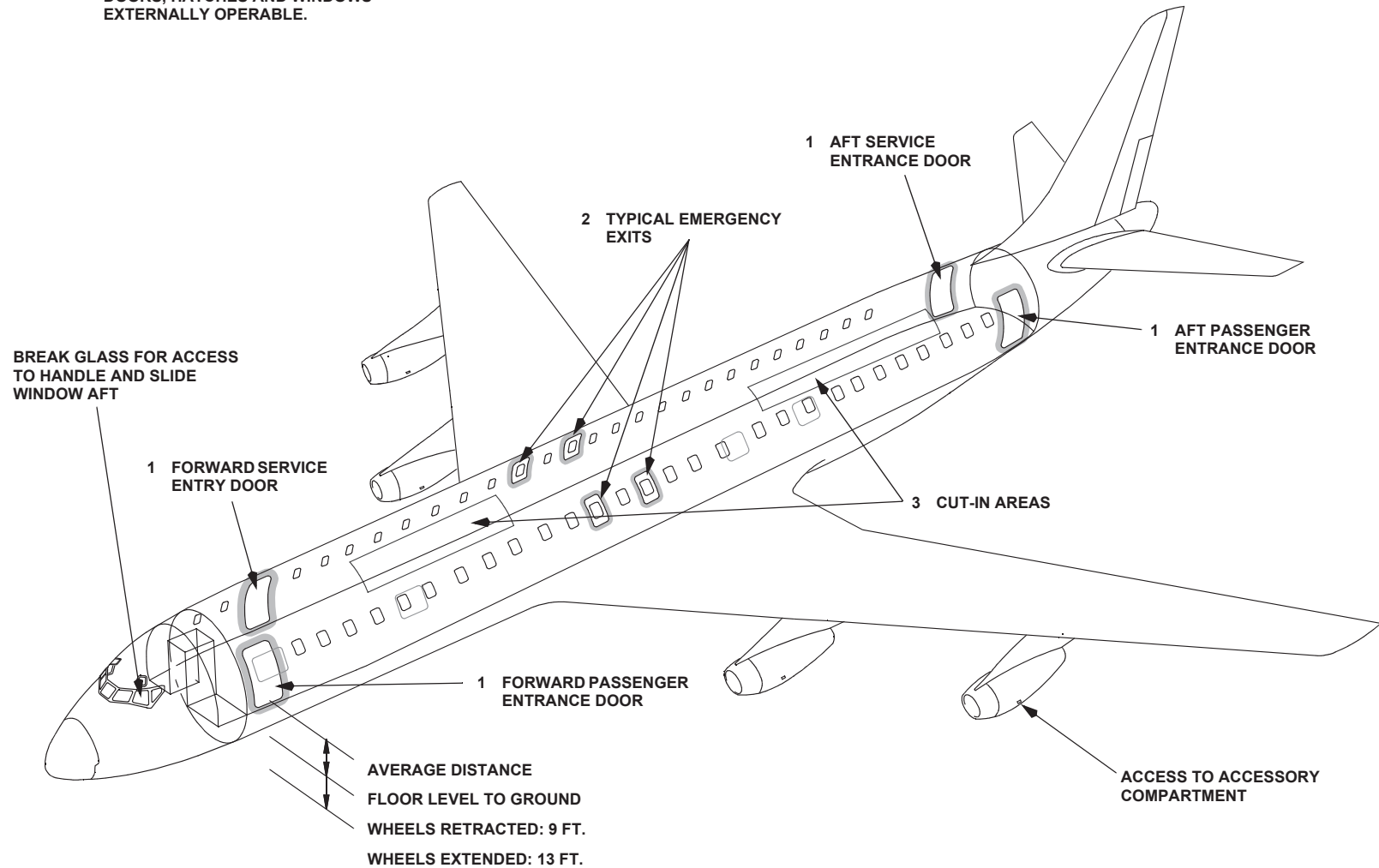

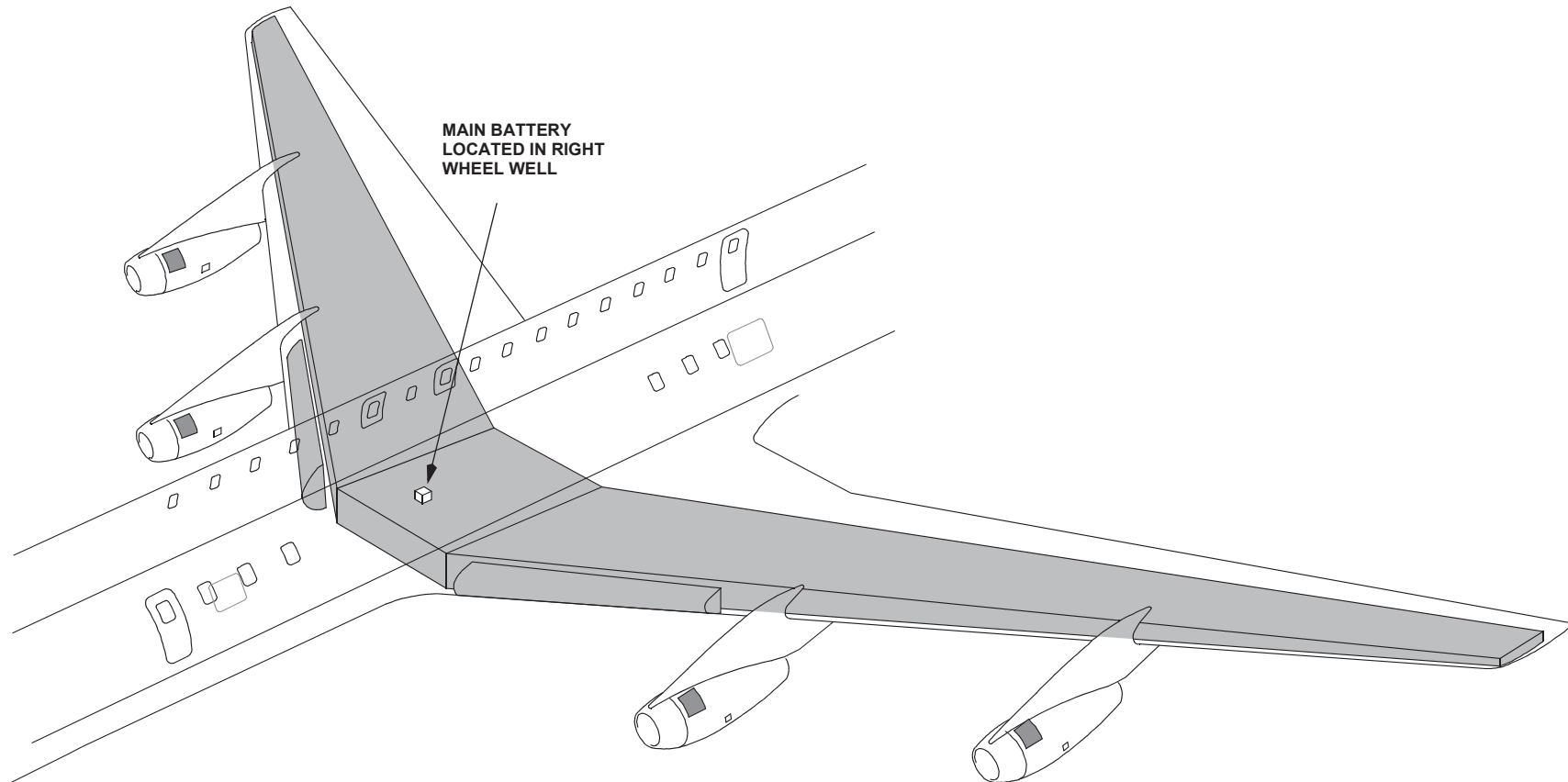

DC-8-63 SERIES

FLAMMABLE MATERIAL LOCATIONS

CAUTION: Rescue crews wearing full PPE to include SCBA's must use caution when moving across sections of aircraft that have been exposed to fatigue or fire as the result of an accident. Crews need to verify the integrity of the surface area before moving their weight and equipment across it. Signs could include but are not limited to deformity of structure, visual signs of flame impingement or uneven surfaces. Surface integrity can be checked with a pike pole, axe or any instrument used to sound surfaces for integrity.

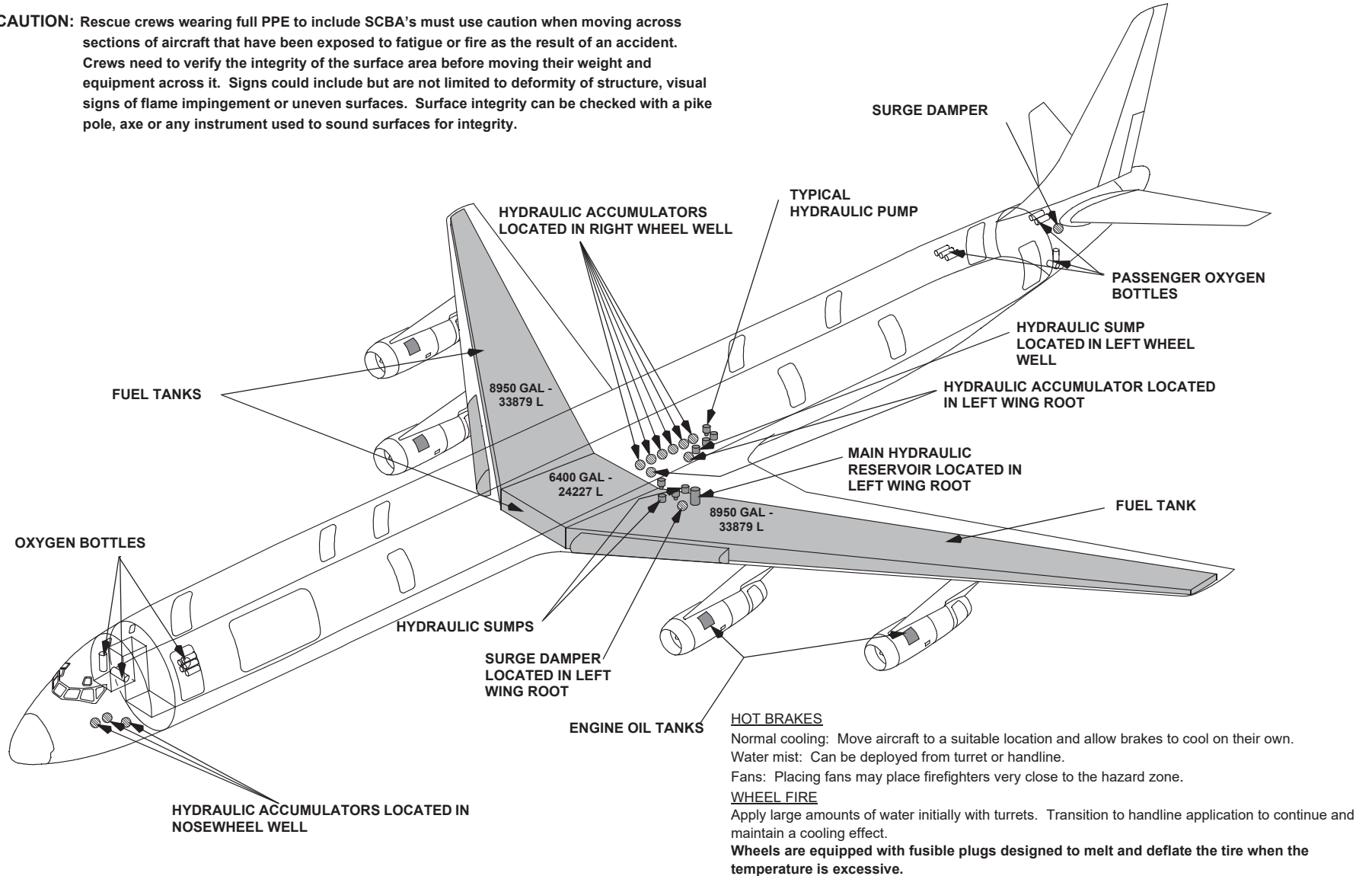

WARNING: Approach landing gear trucks from forward or aft at a 45 degree angle when approaching hot brakes or fighting a wheel fire, as rims and tires may pose a fragmentation hazard.

DC-8-63 SERIES

EMERGENCY RESCUE ACCESS-1

1 PASSENGER AND SERVICE DOORS

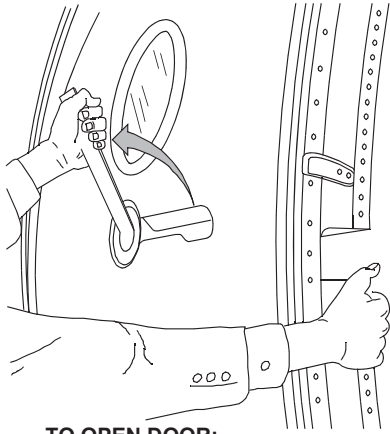

- TO OPEN DOOR:**
1. PULL HANDLE FROM RECESS.
 2. ROTATE HANDLE FORWARD.
 3. PULL DOOR OPEN.

2 OVERWING EMERGENCY EXITS

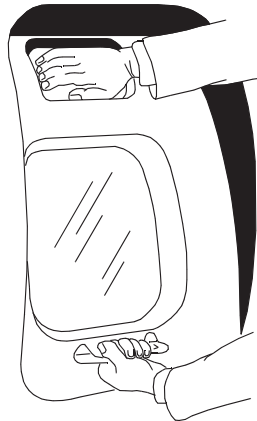

- TO OPEN DOOR:**
1. HOLD HANDLE.
 2. PUSH RELEASE PLATE (HANDLE ON SOME AIRPLANES ONLY).

3 FORWARD UPPER CARGO DOOR EXTERNAL CONTROL PANEL

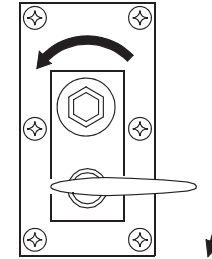

- TO OPEN DOOR:**
1. PUSH LOCKPIN HANDLE DOWN AND HOLD.
 2. INSERT WRENCH IN HEX END OF DOOR HANDLE SHAFT AND ROTATE. COUNTERCLOCKWISE TO UNLATCH
 3. ATTACH SLING TO DOOR AND HOIST DOOR OPEN.

4 EMERGENCY EXIT DOORS

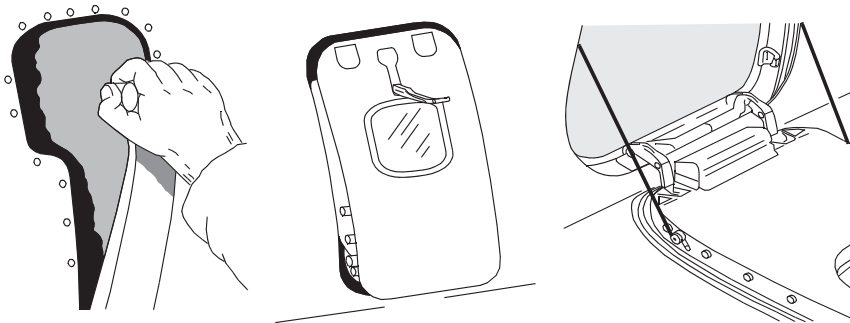

- TO OPEN DOOR:**
1. PULL HANDLE FROM RECESS.
 2. ROTATE HANDLE FORWARD.
 3. PULL DOOR OPEN.

5 CUT-IN AREAS

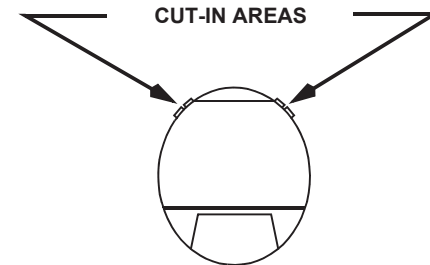

NOTE: CUT-IN AREAS REQUIRE METAL CUTTING PORTABLE POWER EQUIPMENT. BECAUSE OF TYPE OF STRUCTURE AND POSSIBLE INJURY TO PERSONNEL WITHIN, IT IS RECOMMENDED THAT MAJOR EFFORT TO GAIN ACCESS BE DIRECTED TO HATCHES AND DOORS. URGENCY OF SITUATION WILL DICTATE THE NECESSITY FOR A CUT-IN.

DC-8-63 SERIES

EMERGENCY RESCUE ACCESS-2

GENERAL NOTE:

1. OBSERVE MARKINGS ON ALL DOORS FOR OPERABILITY. DO NOT ATTEMPT TO OPEN DOORS WHICH ARE Banded OR MARKED INOPERABLE.
2. DO NOT STAND IN FRONT OF PASSENGER SERVICE OR EMERGENCY EXIT DOORS WHEN OPENING. ESCAPE SLIDE WILL INFLATE AUTOMATICALLY WHEN DOOR IS OPENED AND DROP OVER LOWERED DOOR.

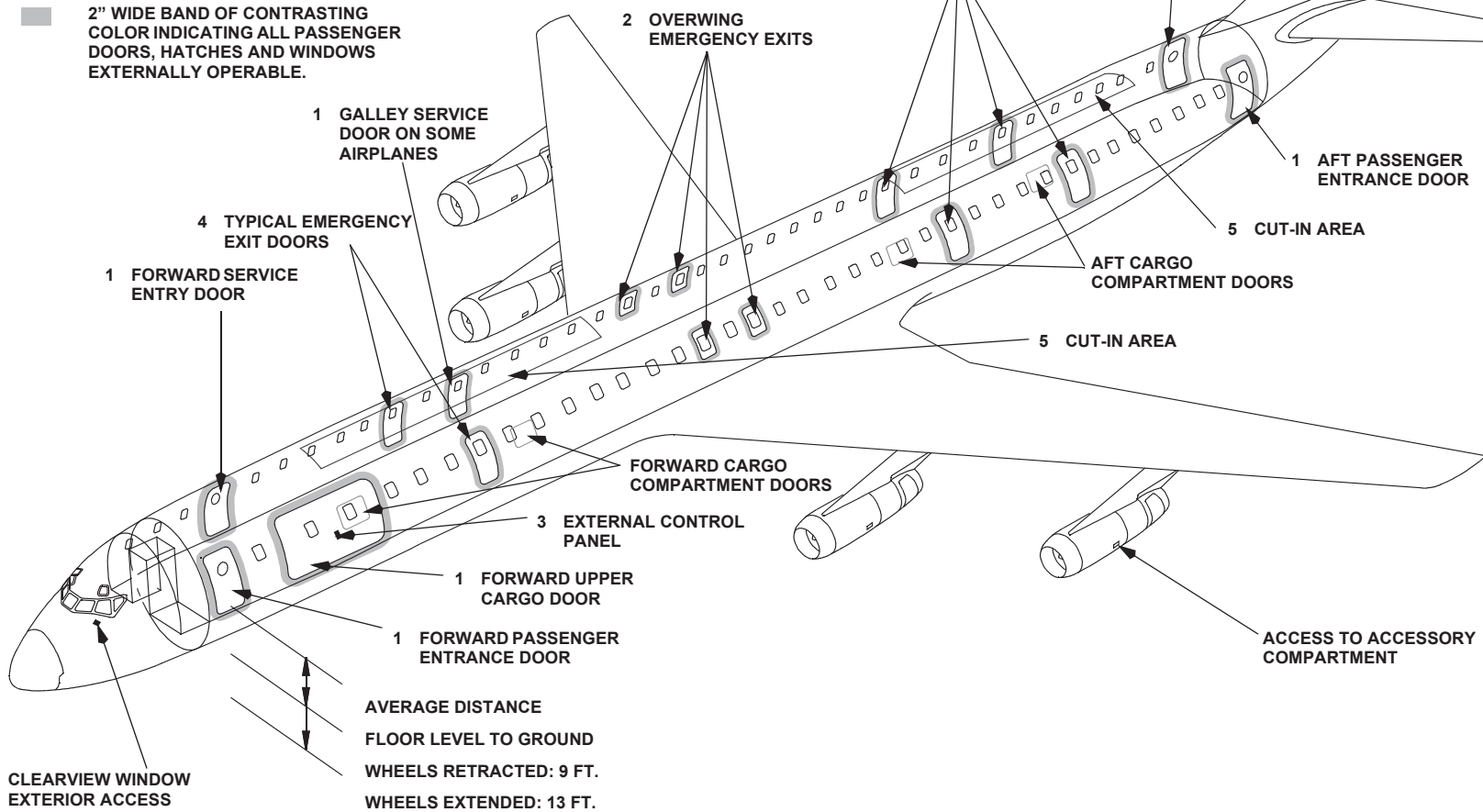

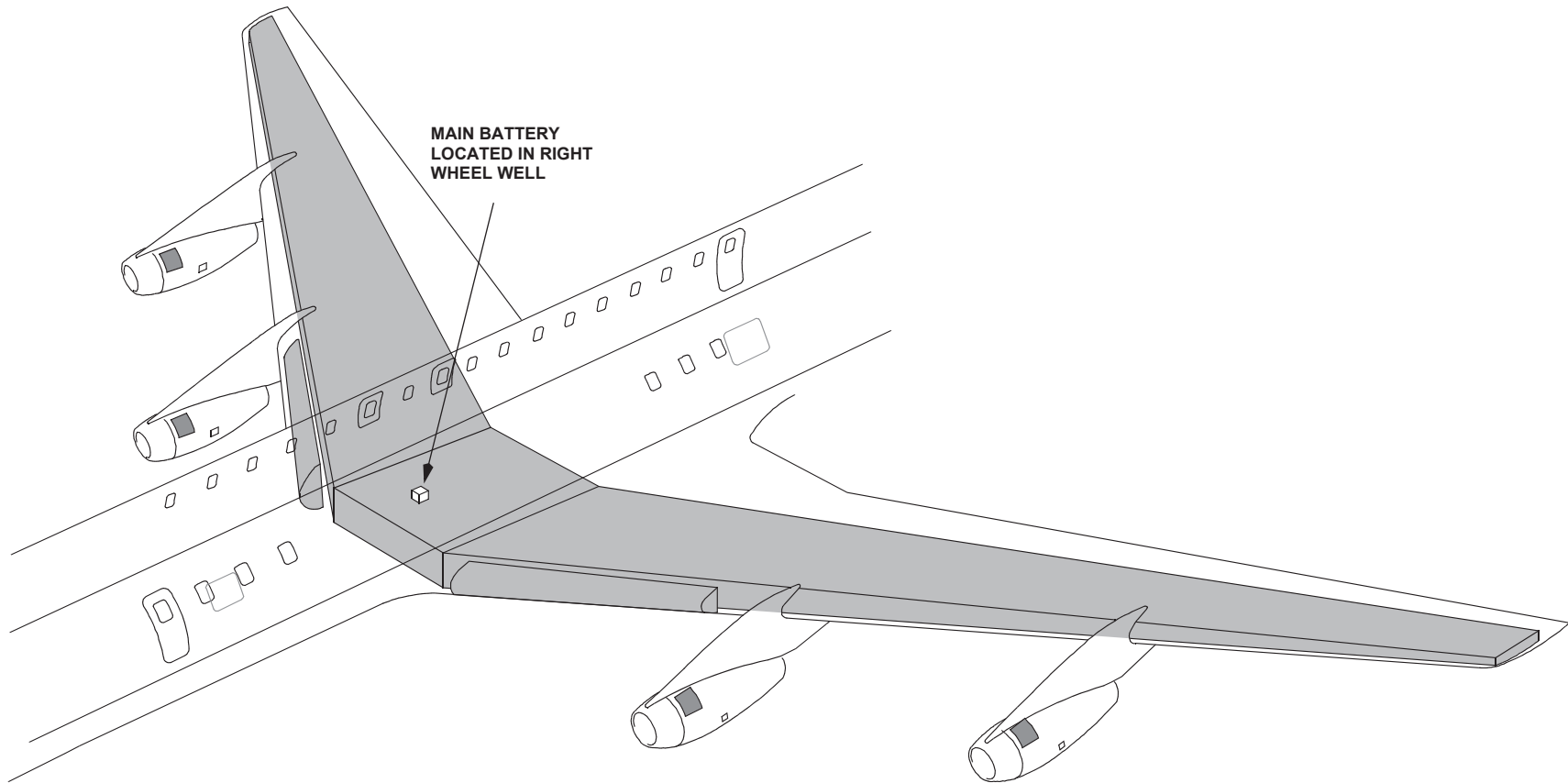

DC-8-71 SERIES

FLAMMABLE MATERIAL LOCATIONS

CAUTION: Rescue crews wearing full PPE to include SCBA's must use caution when moving across sections of aircraft that have been exposed to fatigue or fire as the result of an accident. Crews need to verify the integrity of the surface area before moving their weight and equipment across it. Signs could include but are not limited to deformity of structure, visual signs of flame impingement or uneven surfaces. Surface integrity can be checked with a pike pole, axe or any instrument used to sound surfaces for integrity.

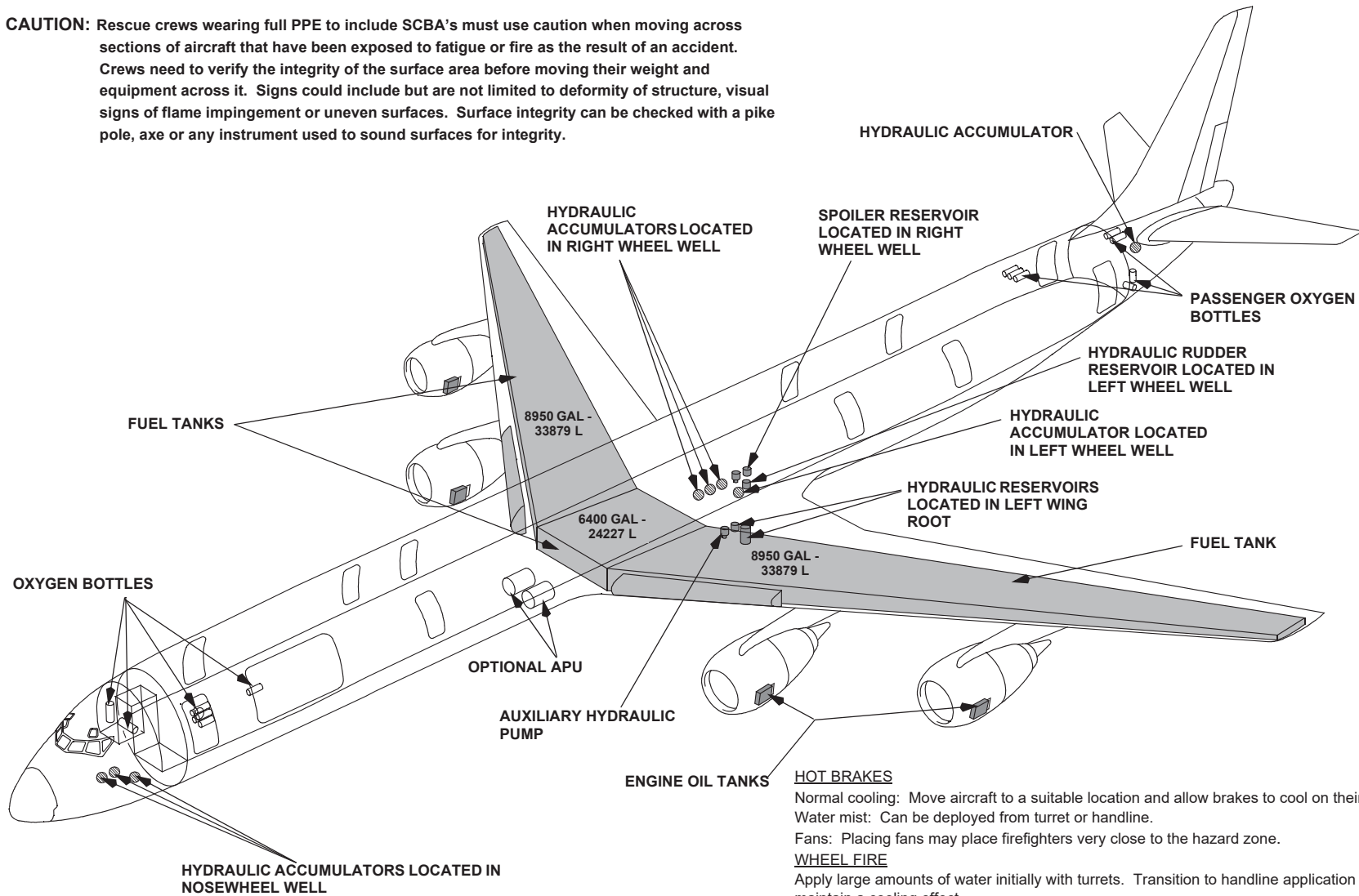

HOT BRAKES
 Normal cooling: Move aircraft to a suitable location and allow brakes to cool on their own.
 Water mist: Can be deployed from turret or handline.
 Fans: Placing fans may place firefighters very close to the hazard zone.

WHEEL FIRE
 Apply large amounts of water initially with turrets. Transition to handline application to continue and maintain a cooling effect.
 Wheels are equipped with fusible plugs designed to melt and deflate the tire when the temperature is excessive.

WARNING: Approach landing gear trucks from forward or aft at a 45 degree angle when approaching hot brakes or fighting a wheel fire, as rims and tires may pose a fragmentation hazard.

Copyright © Boeing. See title page for details.

DC-8-71 SERIES

EMERGENCY RESCUE ACCESS-1

1 PASSENGER AND SERVICE DOORS

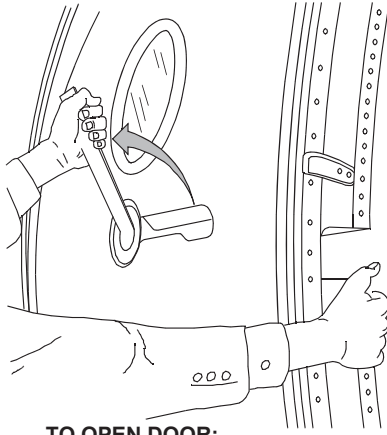

- TO OPEN DOOR:**
1. PULL HANDLE FROM RECESS.
 2. ROTATE HANDLE FORWARD.
 3. PULL DOOR OPEN.

2 OVERWING EMERGENCY EXITS

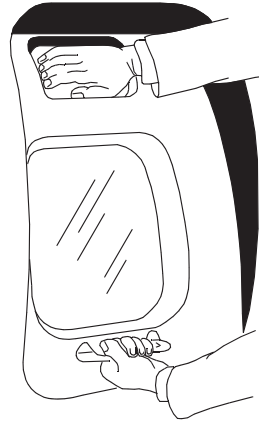

- TO OPEN DOOR:**
1. HOLD HANDLE.
 2. PUSH RELEASE PLATE (HANDLE ON SOME AIRPLANES ONLY).

3 FORWARD UPPER CARGO DOOR EXTERNAL CONTROL PANEL

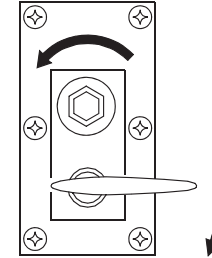

- TO OPEN DOOR:**
1. PUSH LOCKPIN HANDLE DOWN AND HOLD
 2. INSERT WRENCH IN HEX END OF DOOR HANDLE SHAFT AND ROTATE. COUNTERCLOCKWISE TO UNLATCH
 3. ATTACH SLING TO DOOR AND HOIST DOOR OPEN.

4 EMERGENCY EXIT DOORS



- TO OPEN DOOR:**
1. PULL HANDLE FROM RECESS.
 2. ROTATE HANDLE FORWARD.
 3. PULL DOOR OPEN.

5 CUT-IN AREAS

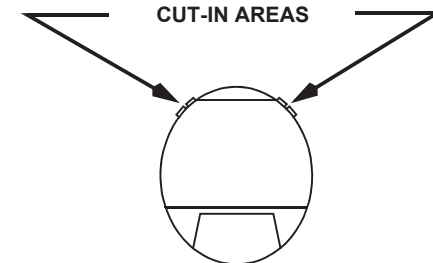

NOTE: CUT-IN AREAS REQUIRE METAL CUTTING PORTABLE POWER EQUIPMENT. BECAUSE OF TYPE OF STRUCTURE AND POSSIBLE INJURY TO PERSONNEL WITHIN, IT IS RECOMMENDED THAT MAJOR EFFORT TO GAIN ACCESS BE DIRECTED TO HATCHES AND DOORS. URGENCY OF SITUATION WILL DICTATE THE NECESSITY FOR A CUT-IN.

DC-8-71 SERIES

EMERGENCY RESCUE ACCESS-2

GENERAL NOTE:

1. OBSERVE MARKINGS ON ALL DOORS FOR OPERABILITY. DO NOT ATTEMPT TO OPEN DOORS WHICH ARE BANDED OR MARKED INOPERABLE.
2. DO NOT STAND IN FRONT OF PASSENGER SERVICE OR EMERGENCY EXIT DOORS WHEN OPENING. ESCAPE SLIDE WILL INFLATE AUTOMATICALLY WHEN DOOR IS OPENED AND DROP OVER LOWERED DOOR.

■ 2" WIDE BAND OF CONTRASTING COLOR INDICATING ALL PASSENGER DOORS, HATCHES AND WINDOWS EXTERNALLY OPERABLE.

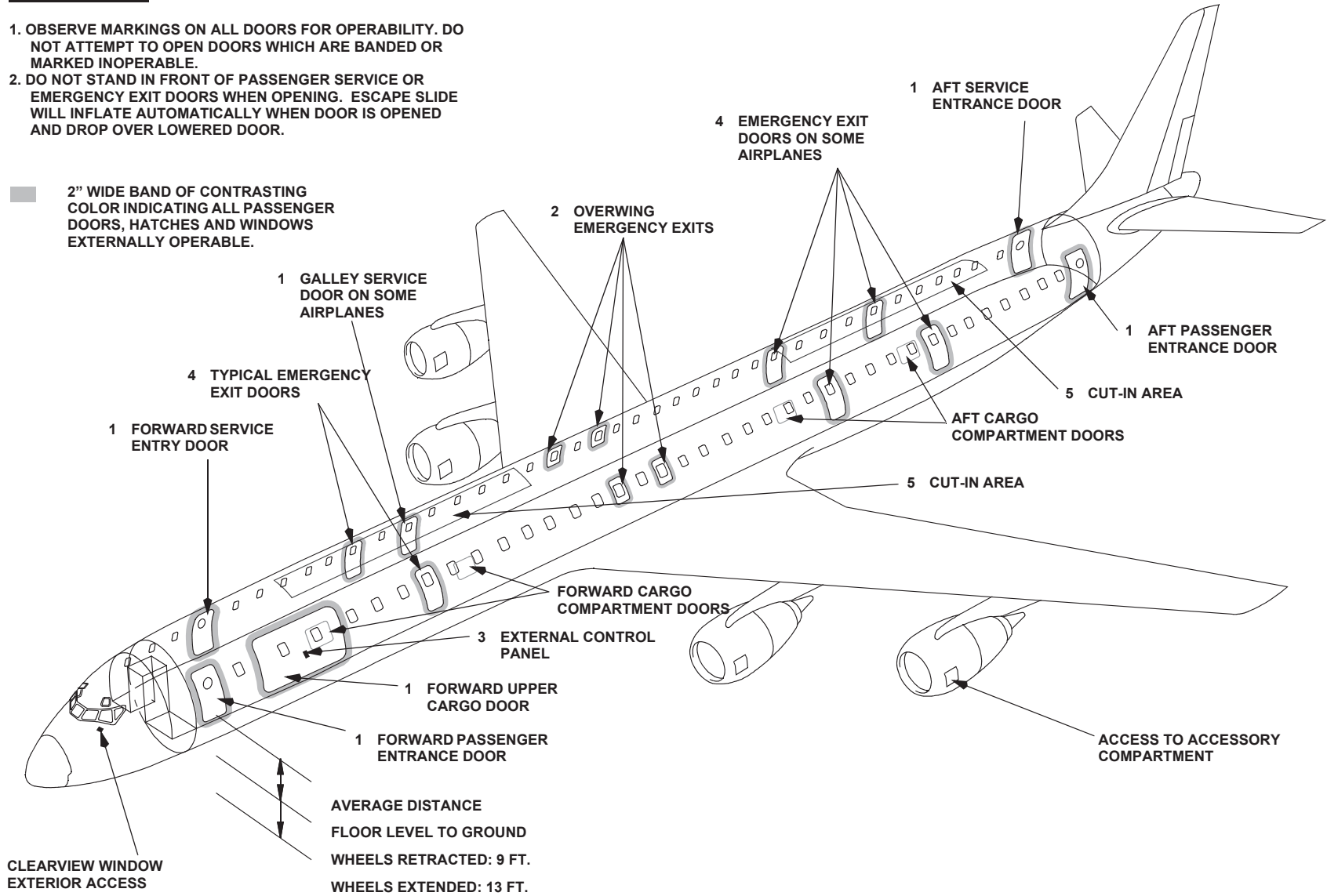

DC-8-71 SERIES

BATTERY LOCATIONS

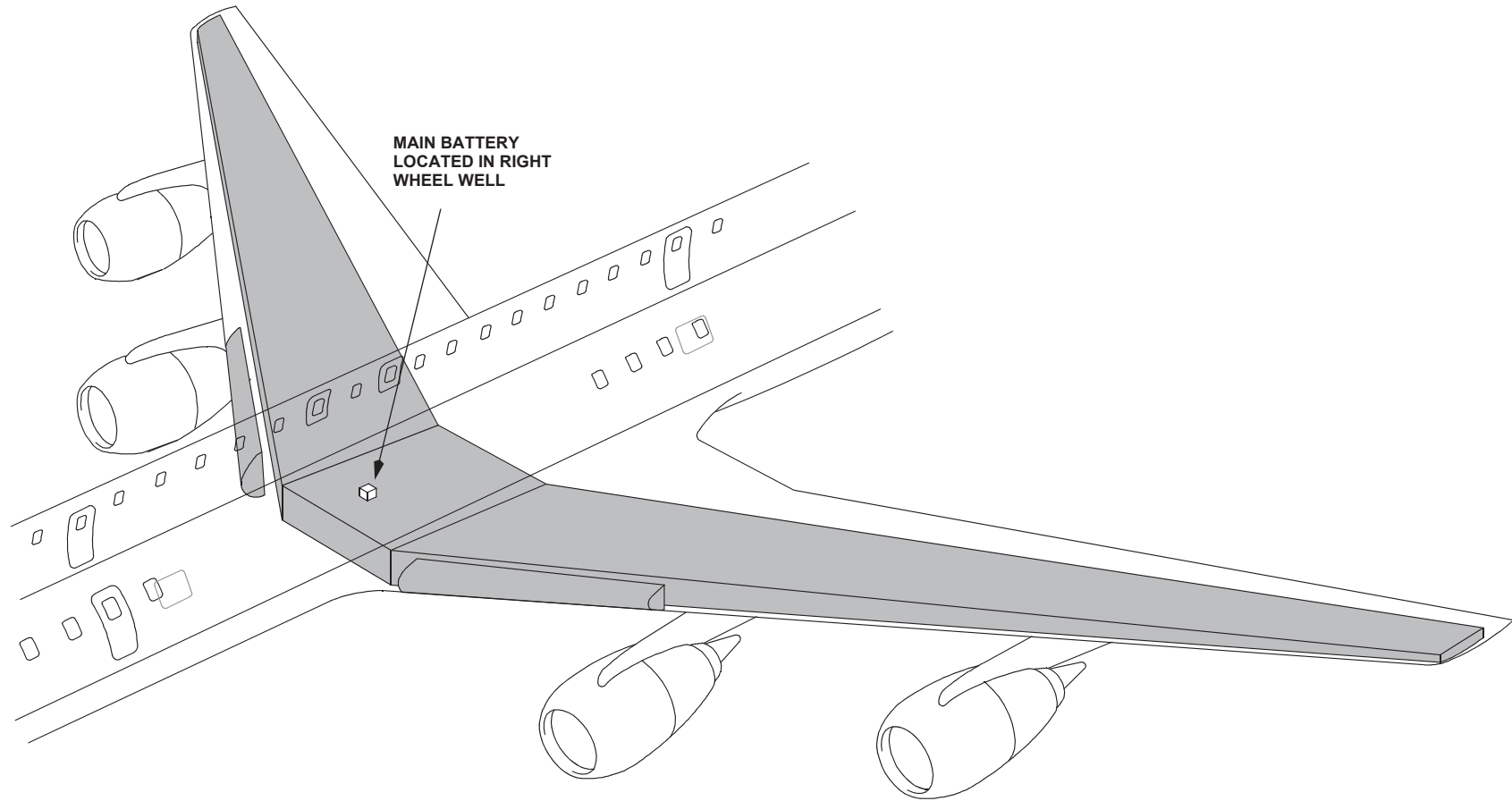

DC-8-72 SERIES

FLAMMABLE MATERIAL LOCATIONS

CAUTION: Rescue crews wearing full PPE to include SCBA's must use caution when moving across sections of aircraft that have been exposed to fatigue or fire as the result of an accident. Crews need to verify the integrity of the surface area before moving their weight and equipment across it. Signs could include but are not limited to deformity of structure, visual signs of flame impingement or uneven surfaces. Surface integrity can be checked with a pike pole, axe or any instrument used to sound surfaces for integrity.

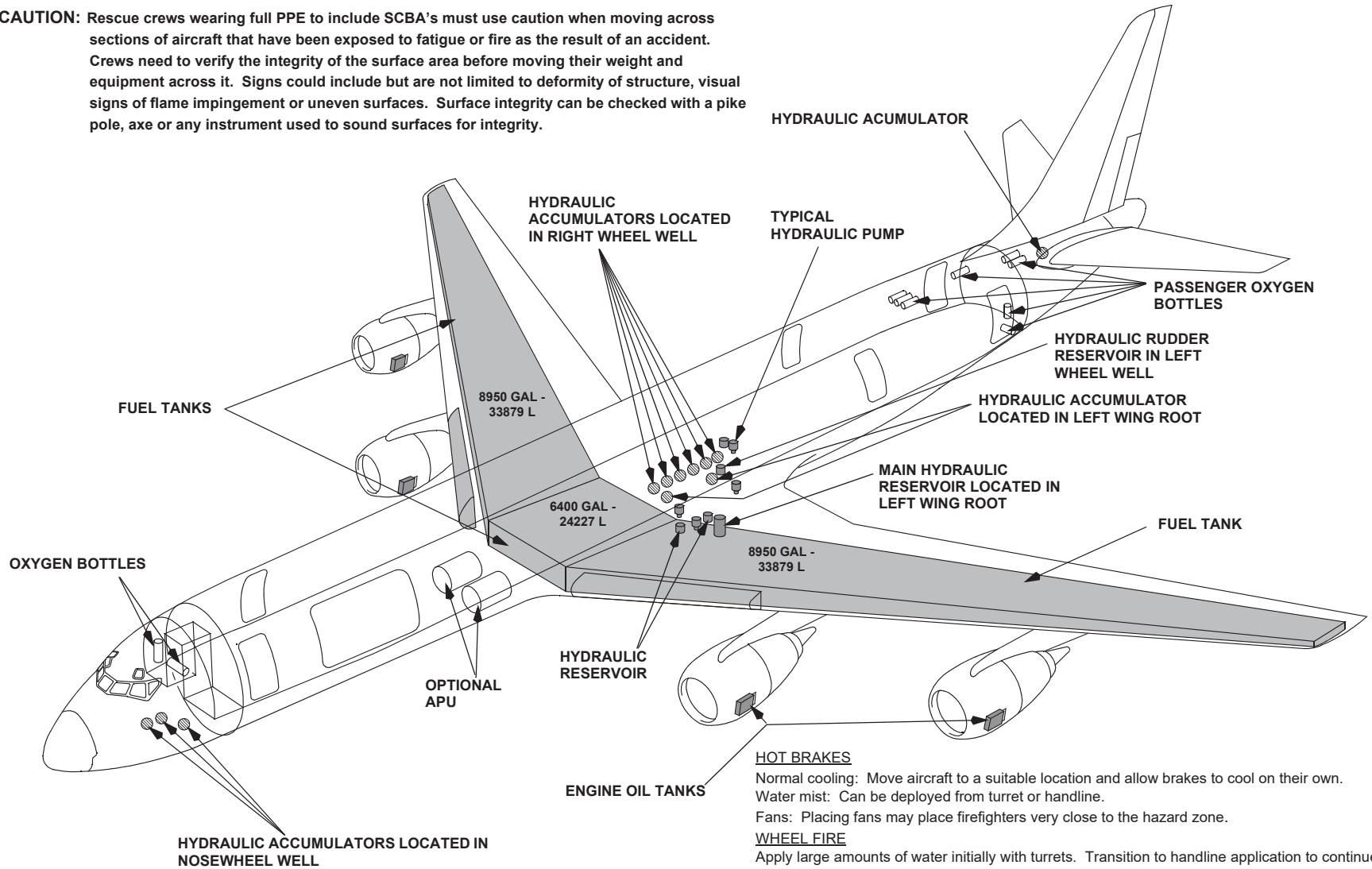

HOT BRAKES
 Normal cooling: Move aircraft to a suitable location and allow brakes to cool on their own.
 Water mist: Can be deployed from turret or handline.
 Fans: Placing fans may place firefighters very close to the hazard zone.

WHEEL FIRE
 Apply large amounts of water initially with turrets. Transition to handline application to continue and maintain a cooling effect.
Wheels are equipped with fusible plugs designed to melt and deflate the tire when the temperature is excessive.

WARNING: Approach landing gear trucks from forward or aft at a 45 degree angle when approaching hot brakes or fighting a wheel fire, as rims and tires may pose a fragmentation hazard.

Copyright © Boeing. See title page for details.

DC-8-72 SERIES

EMERGENCY RESCUE ACCESS-1

1 PASSENGER AND SERVICE DOORS

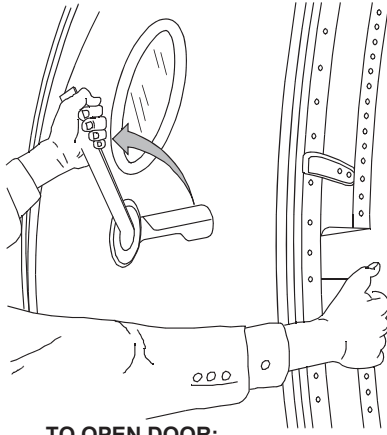

- TO OPEN DOOR:**
1. PULL HANDLE FROM RECESS.
 2. ROTATE HANDLE FORWARD.
 3. PULL DOOR OPEN.

2 OVERWING EMERGENCY EXITS

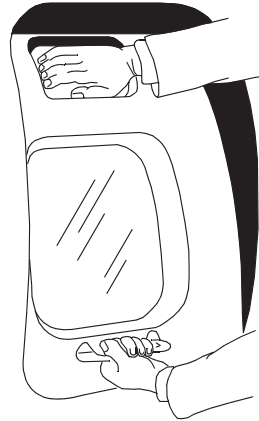

- TO OPEN DOOR:**
1. HOLD HANDLE.
 2. PUSH RELEASE PLATE (HANDLE ON SOME AIRPLANES ONLY).

3 FORWARD UPPER CARGO DOOR EXTERNAL CONTROL PANEL

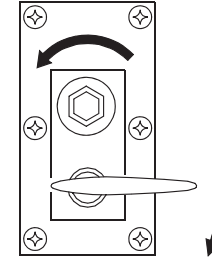

- TO OPEN DOOR:**
1. PUSH LOCKPIN HANDLE DOWN AND HOLD.
 2. INSERT WRENCH IN HEX END OF DOOR HANDLE SHAFT AND ROTATE COUNTERCLOCKWISE TO UNLATCH.
 3. ATTACH SLING TO DOOR AND HOIST DOOR OPEN.

4 EMERGENCY EXIT DOORS

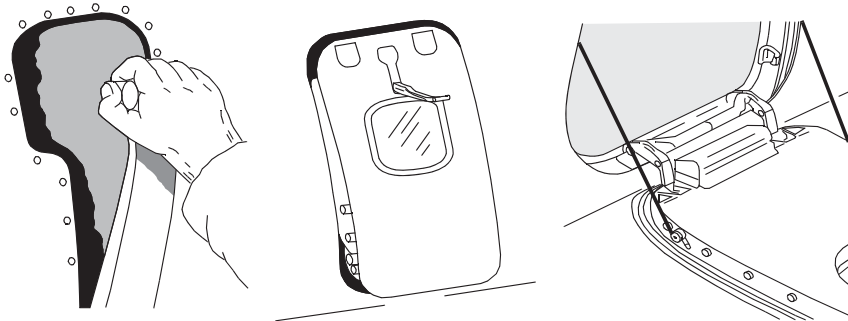

- TO OPEN DOOR:**
1. PULL HANDLE FROM RECESS.
 2. ROTATE HANDLE FORWARD.
 3. PULL DOOR OPEN.

5 CUT-IN AREAS

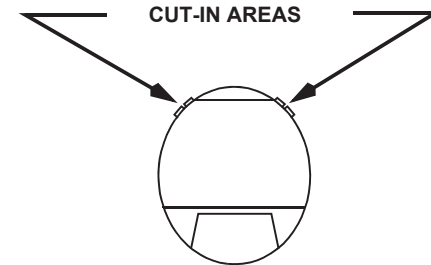

NOTE: CUT-IN AREAS REQUIRE METAL CUTTING PORTABLE POWER EQUIPMENT. BECAUSE OF TYPE OF STRUCTURE AND POSSIBLE INJURY TO PERSONNEL WITHIN, IT IS RECOMMENDED THAT MAJOR EFFORT TO GAIN ACCESS BE DIRECTED TO HATCHES AND DOORS. URGENCY OF SITUATION WILL DICTATE THE NECESSITY FOR A CUT-IN.

DC-8-72 SERIES

EMERGENCY RESCUE ACCESS-2

GENERAL NOTE:

1. OBSERVE MARKINGS ON ALL DOORS FOR OPERABILITY. DO NOT ATTEMPT TO OPEN DOORS WHICH ARE BANDED OR MARKED INOPERABLE.
2. DO NOT STAND IN FRONT OF PASSENGER SERVICE OR EMERGENCY EXIT DOORS WHEN OPENING. ESCAPE SLIDE WILL INFLATE AUTOMATICALLY WHEN DOOR IS OPENED AND DROP OVER LOWERED DOOR.

■ 2" WIDE BAND OF CONTRASTING COLOR INDICATING ALL PASSENGER DOORS, HATCHES AND WINDOWS EXTERNALLY OPERABLE.

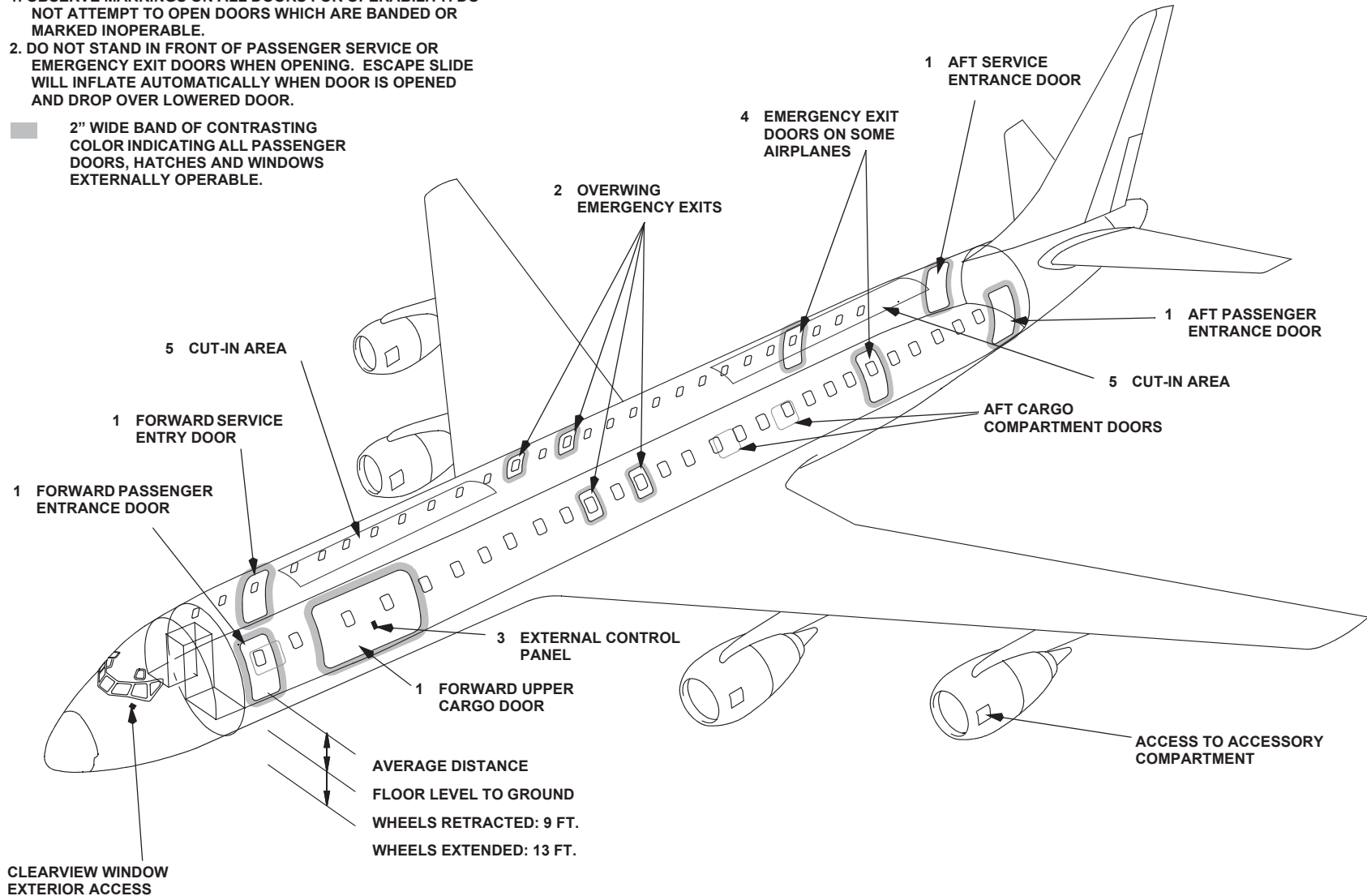

DC-8-72 SERIES

BATTERY LOCATIONS

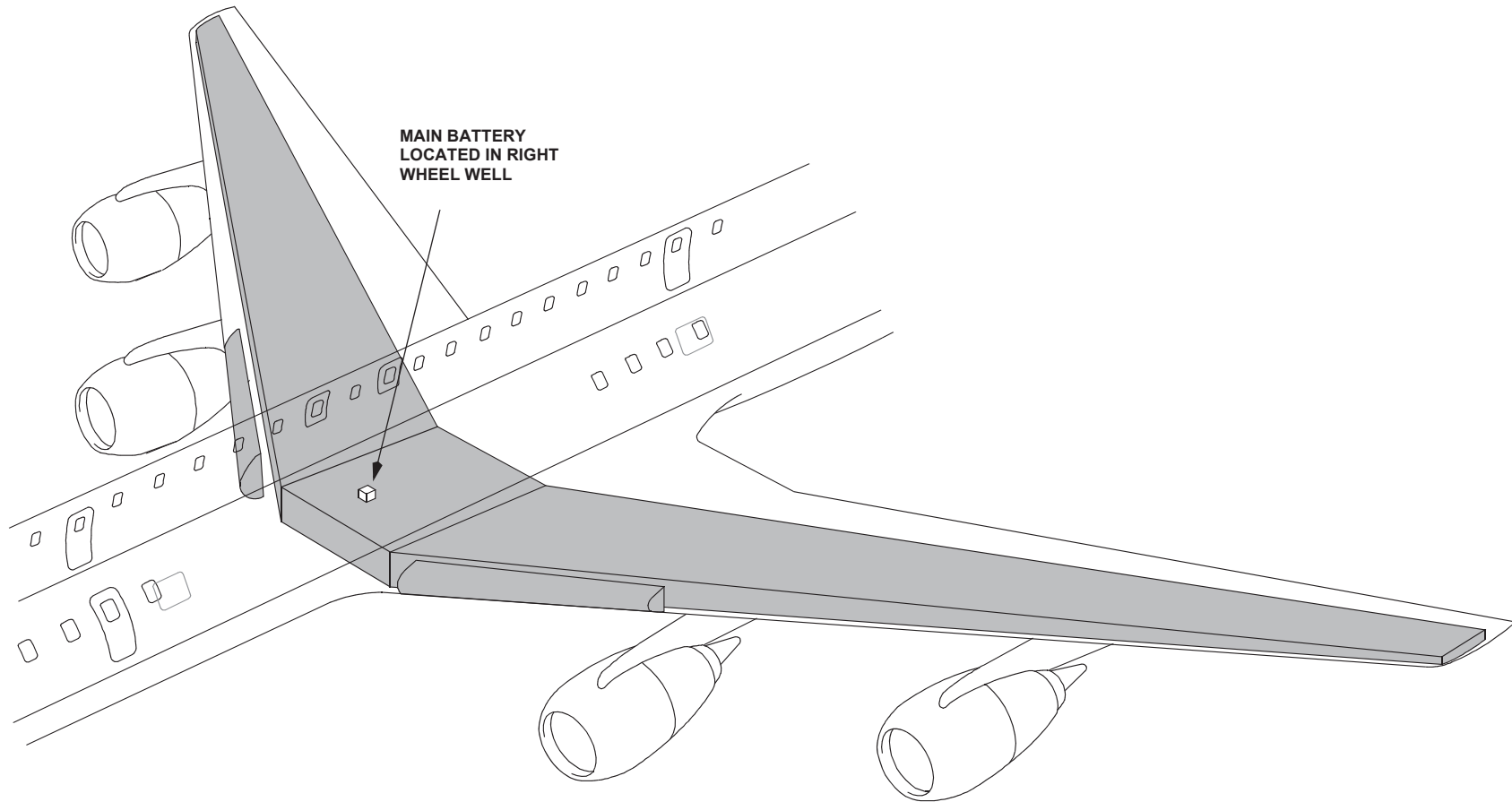

DC-8-73 SERIES

FLAMMABLE MATERIAL LOCATIONS

CAUTION: Rescue crews wearing full PPE to include SCBA's must use caution when moving across sections of aircraft that have been exposed to fatigue or fire as the result of an accident. Crews need to verify the integrity of the surface area before moving their weight and equipment across it. Signs could include but are not limited to deformity of structure, visual signs of flame impingement or uneven surfaces. Surface integrity can be checked with a pike pole, axe or any instrument used to sound surfaces for integrity.

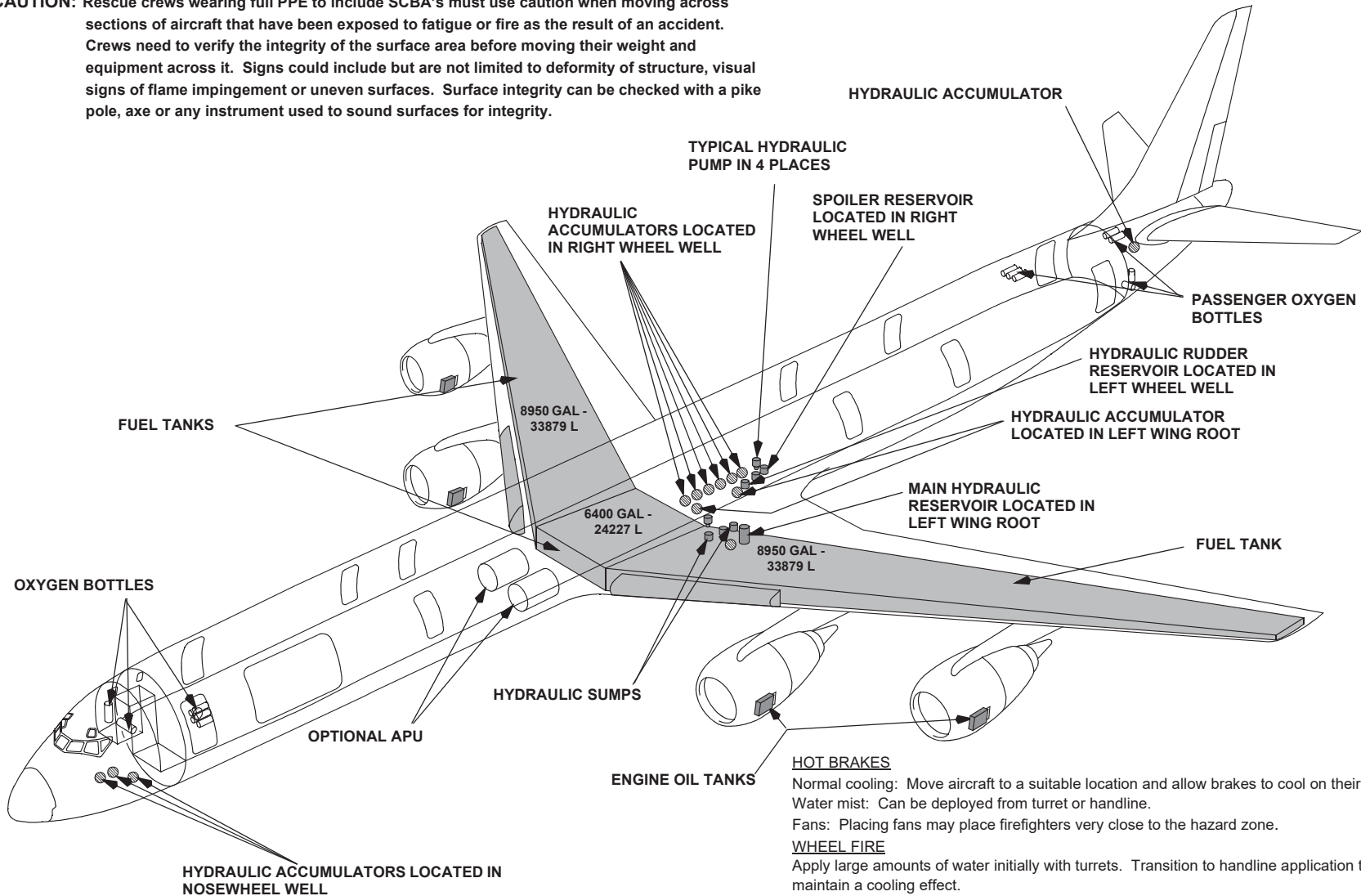

HOT BRAKES
 Normal cooling: Move aircraft to a suitable location and allow brakes to cool on their own.
 Water mist: Can be deployed from turret or handline.
 Fans: Placing fans may place firefighters very close to the hazard zone.

WHEEL FIRE
 Apply large amounts of water initially with turrets. Transition to handline application to continue and maintain a cooling effect.
 Wheels are equipped with fusible plugs designed to melt and deflate the tire when the temperature is excessive.

WARNING: Approach landing gear trucks from forward or aft at a 45 degree angle when approaching hot brakes or fighting a wheel fire, as rims and tires may pose a fragmentation hazard.

DC-8-73 SERIES

EMERGENCY RESCUE ACCESS-1

1 PASSENGER AND SERVICE DOORS

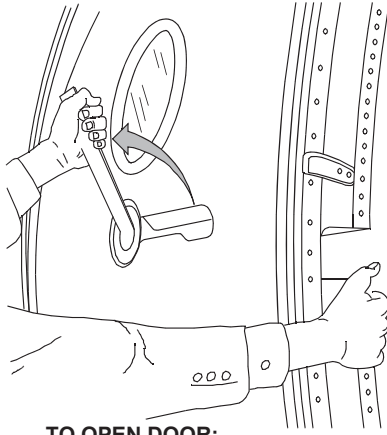

- TO OPEN DOOR:**
1. PULL HANDLE FROM RECESS.
 2. ROTATE HANDLE FORWARD.
 3. PULL DOOR OPEN.

2 OVERWING EMERGENCY EXITS

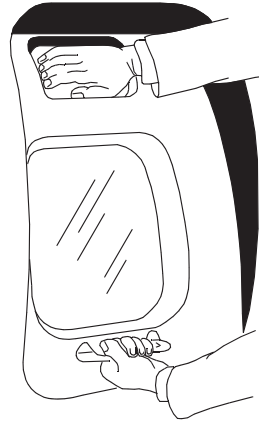

- TO OPEN DOOR:**
1. HOLD HANDLE.
 2. PUSH RELEASE PLATE (HANDLE ON SOME AIRPLANES ONLY).

3 FORWARD UPPER CARGO DOOR EXTERNAL CONTROL PANEL

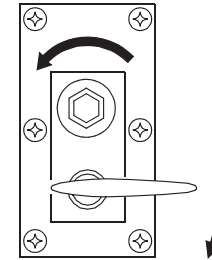

- TO OPEN DOOR:**
1. PUSH LOCKPIN HANDLE DOWN AND HOLD.
 2. INSERT WRENCH IN HEX END OF DOOR HANDLE SHAFT AND ROTATE COUNTERCLOCKWISE TO UNLATCH.
 3. ATTACH SLING TO DOOR AND HOIST DOOR OPEN.

4 EMERGENCY EXIT DOORS



- TO OPEN DOOR:**
1. PULL HANDLE FROM RECESS.
 2. ROTATE HANDLE FORWARD.
 3. PULL DOOR OPEN.

5 CUT-IN AREAS

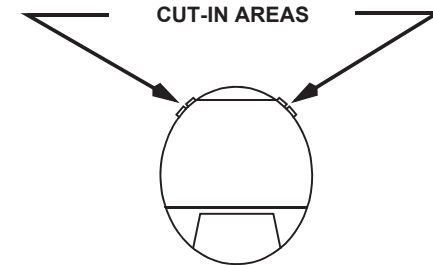

NOTE: CUT-IN AREAS REQUIRE METAL CUTTING PORTABLE POWER EQUIPMENT. BECAUSE OF TYPE OF STRUCTURE AND POSSIBLE INJURY TO PERSONNEL WITHIN, IT IS RECOMMENDED THAT MAJOR EFFORT TO GAIN ACCESS BE DIRECTED TO HATCHES AND DOORS. URGENCY OF SITUATION WILL DICTATE THE NECESSITY FOR A CUT-IN.

DC-8-73 SERIES

EMERGENCY RESCUE ACCESS-2

GENERAL NOTE:

1. OBSERVE MARKINGS ON ALL DOORS FOR OPERABILITY. DO NOT ATTEMPT TO OPEN DOORS WHICH ARE BANDED OR MARKED INOPERABLE.
2. DO NOT STAND IN FRONT OF PASSENGER SERVICE OR EMERGENCY EXIT DOORS WHEN OPENING. ESCAPE SLIDE WILL INFLATE AUTOMATICALLY WHEN DOOR IS OPENED AND DROP OVER LOWERED DOOR.

■ 2" WIDE BAND OF CONTRASTING COLOR INDICATING ALL PASSENGER DOORS, HATCHES AND WINDOWS EXTERNALLY OPERABLE.

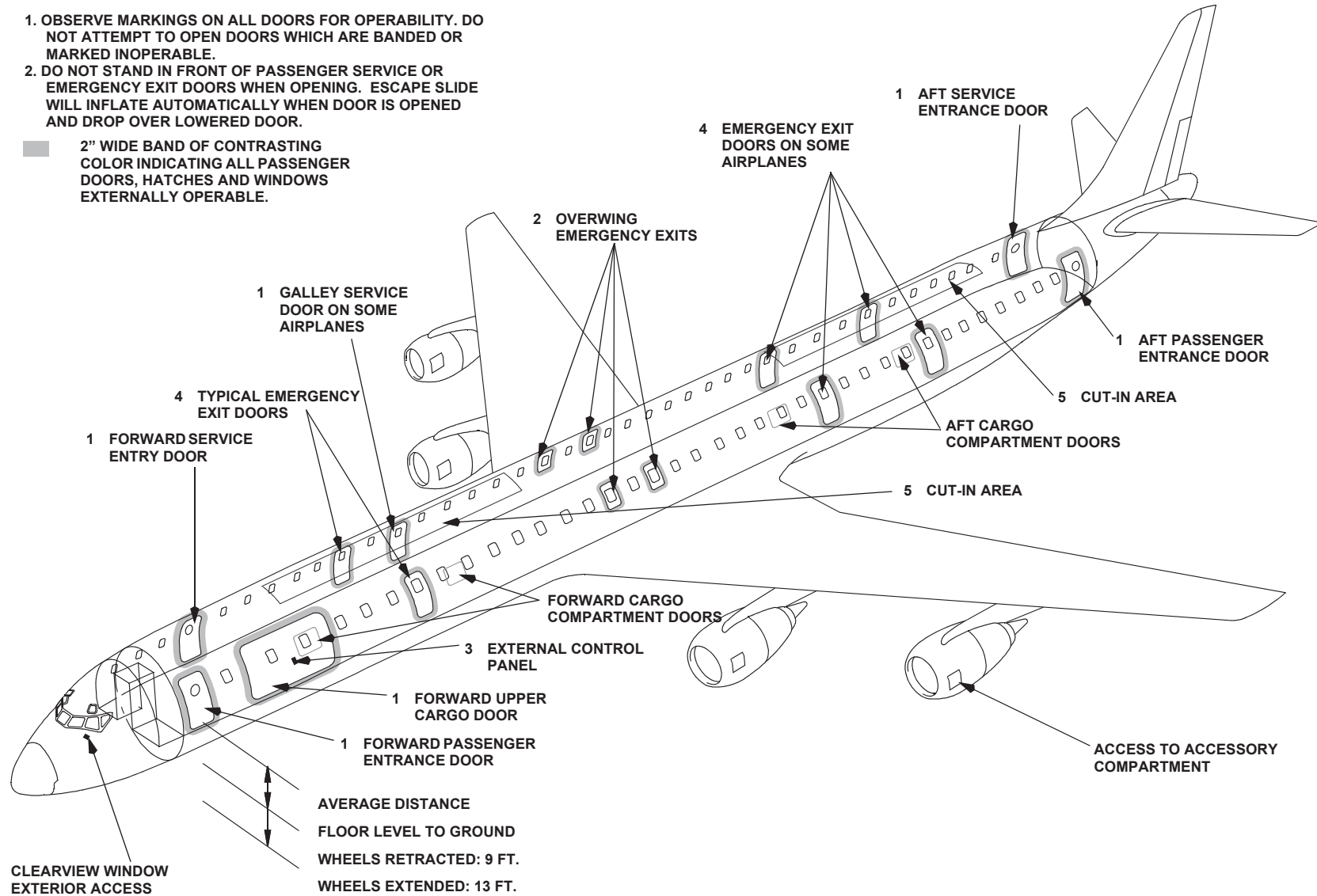

DC-8-73 SERIES

BATTERY LOCATIONS

